

A Life History Review for Red Snapper in the Gulf of Mexico
with an Evaluation of the Importance of Offshore Petroleum
Platforms and Other Artificial Reefs

Benny J. Gallaway, Stephen T. Szedlmayer, William J. Gazey

SEDAR31-RD18

13 August 2012

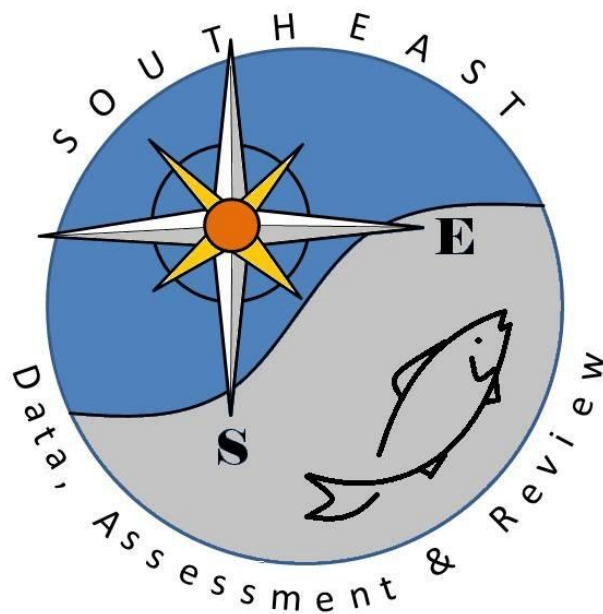

This article was downloaded by: [Auburn University]

On: 29 January 2009

Access details: Access Details: [subscription number 790393106]

Publisher Taylor & Francis

Informa Ltd Registered in England and Wales Registered Number: 1072954 Registered office: Mortimer House, 37-41 Mortimer Street, London W1T 3JH, UK

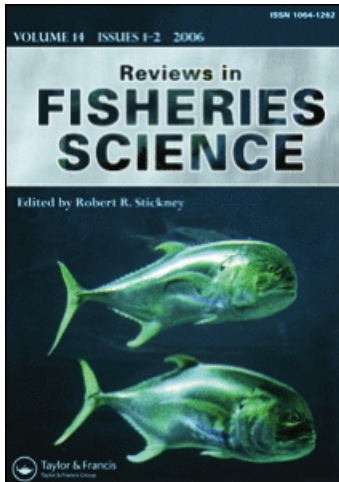

Reviews in Fisheries Science

Publication details, including instructions for authors and subscription information:

<http://www.informaworld.com/smpp/title-content=t713610918>

A Life History Review for Red Snapper in the Gulf of Mexico with an Evaluation of the Importance of Offshore Petroleum Platforms and Other Artificial Reefs

Benny J. Gallaway ^a; Stephen T. Szedlmayer ^b; William J. Gazey ^c

^a LGL Ecological Research Associates, Inc., Bryan, Texas, USA ^b Department of Fisheries and Allied Aquacultures, Auburn University, Alabama, USA ^c Gazey Research, Victoria, British Columbia, Canada

First Published on: 01 January 2009

To cite this Article Gallaway, Benny J., Szedlmayer, Stephen T. and Gazey, William J. (2009) 'A Life History Review for Red Snapper in the Gulf of Mexico with an Evaluation of the Importance of Offshore Petroleum Platforms and Other Artificial Reefs', *Reviews in Fisheries Science*, 17:1, 48 — 67

To link to this Article: DOI: 10.1080/10641260802160717

URL: <http://dx.doi.org/10.1080/10641260802160717>

PLEASE SCROLL DOWN FOR ARTICLE

Full terms and conditions of use: <http://www.informaworld.com/terms-and-conditions-of-access.pdf>

This article may be used for research, teaching and private study purposes. Any substantial or systematic reproduction, re-distribution, re-selling, loan or sub-licensing, systematic supply or distribution in any form to anyone is expressly forbidden.

The publisher does not give any warranty express or implied or make any representation that the contents will be complete or accurate or up to date. The accuracy of any instructions, formulae and drug doses should be independently verified with primary sources. The publisher shall not be liable for any loss, actions, claims, proceedings, demand or costs or damages whatsoever or howsoever caused arising directly or indirectly in connection with or arising out of the use of this material.

A Life History Review for Red Snapper in the Gulf of Mexico with an Evaluation of the Importance of Offshore Petroleum Platforms and Other Artificial Reefs

BENNY J. GALLAWAY,¹ STEPHEN T. SZEDLMAYER,²
and WILLIAM J. GAZEY³

¹LGL Ecological Research Associates, Inc., Bryan, Texas, USA

²Department of Fisheries and Allied Aquacultures, Auburn University, Alabama, USA

³Gazey Research, Victoria, British Columbia, Canada

Red snapper mature as early as age 2, have high fecundity (a 10-year-old female produces 60 million eggs per year), and may live for over 50 years. Eggs, larvae, and post-settlement juveniles typically show high rates of natural mortality. For example, of the 60 million eggs produced annually by a 10-year-old female, only about 450 would survive to 5 cm, the size at which they enter the shrimp fishery. Changes in abundance by size and age appear to be consistent with density dependence in survival rate from ages 0 to 1 and likely ages 0 to 2. Red snapper are attracted to structure or reef habitat at all ages, but larger, older fish also occur over open habitat once they have reached a size that renders them largely invulnerable to predation. Artificial reefs comprise a small fraction of the overall high-relief reef habitat, but harbor a large fraction of the present-day age 2 red snapper populations. Prior to the proliferation of artificial reefs in the northern Gulf, age 2 red snapper may have historically occurred mainly over open-bottom, sand-mud benthic habitat where natural and shrimp trawl bycatch mortality was high. Age 2 fish dominate red snapper populations at artificial reefs, whereas the age composition of red snapper at natural reefs usually show older ages are dominant. The present day red snapper fishery is heavily dependent on catches at artificial reefs. Evidence is presented that suggests red snapper production in the northern Gulf likely has been increased by the establishment of significant numbers of artificial reefs.

Keywords red snapper, *Lutjanus campechanus*, oil and gas platforms, density-dependent mortality, life history, artificial reefs

INTRODUCTION

The red snapper *Lutjanus campechanus* is an unusual finfish. In the Gulf of Mexico (Gulf), red snapper mature at age 2 and can live for over 50 years (Szedlmayer and Shipp, 1994; Render, 1995; Wilson and Nieland, 2001). They are also characterized by high fecundity. A female age 0 red snapper recruit produces, on average, 55.5 million eggs over its lifespan (SEDAR7, 2005).

Address correspondence to Benny Gallaway, LGL Ecological Research Associates, Inc., 1410 Cavitt Street, Bryan, TX 77801 USA. E-mail: bgallaway@lgl.com

This is more than an order of magnitude higher than any of the finfishes listed in the Ransom Myers' Stock Recruitment Database (2007).

Despite these attributes, the Gulf population of red snapper has been in an overfished condition since at least 1994 (Goodyear, 1994), and rebuilding efforts to date have been unsuccessful (SEDAR7, 2005). Generally, this failure is believed to have been attributable to the inability to reduce shrimp trawl bycatch while maintaining a high total allowable catch (TAC) in the directed fishery. However, shrimp trawl bycatch mortality of red snapper has plummeted since 2003, but there has not been any evidence that the abundance of age 1 juveniles

has increased substantially. A possible explanation is that habitat limitation (or compensatory mortality) may be an important population control, particularly during the early life stages of red snapper.

Shipp (1999) noted that the addition of large amounts of artificial reef habitat (over 20,000 individual reefs installed) in an area offshore of Alabama was coincident with the establishment of a significant red snapper fishery. This area had formerly been devoid of all but relatively diminutive soft-bottom fish species of little or no economic importance. He noted that the ichthyofauna of a quarter century prior had been transformed from an economically depauperate biomass to one supporting an industry valued at \$60 million annually. He rhetorically asked if this change had resulted in a change in total biomass? His answer was: "We don't know, but did it matter in terms of management decisions?" (Shipp, 1999:54).

Cowan et al. (1999) responded that "yes, it mattered" because a fundamental change in habitat (the placement of artificial reefs) had occurred at the expense of the small benthic fisheries in a region of the shelf that had formerly provided a nursery function to many species of fishes. They argued that nursery function had been traded for adult habitat, complete with a rich set of predators, without any consideration of the ecosystem consequences of the tradeoffs. They suggested that large-scale deployment of artificial reefs could result in large-scale modification of ecosystem function, with effects good and bad depending on specifics of critical habitat requirements and recruitment bottlenecks.

Trawl samples of today (e.g., Wells, 2007) suggest that the addition of artificial reef habitat offshore Alabama has not resulted in an area-wide displacement or loss of the soft-bottom ichthyofauna as characterized by Shipp (1999). These species still occur and dominate trawl samples. However, an increase in adult reef species has occurred that has been coincident with artificial reef placement. As will be shown below, these new populations of large predators indeed forage on prey species inhabiting the surrounding soft bottoms, as well as on reef-associated and water column organisms. The magnitude of the overall effects of artificial reefs on productivity and ecosystem function remains unanswered. Also, the question of whether the placement of artificial reefs actually increases production or merely aggregates species such as red snapper remains contentious.

In this article, we review the literature describing the life history, distribution, and ecology of the red snapper in the Gulf of Mexico. Specifically, we examine the role and relative importance of offshore oil and gas platforms and other artificial reefs as factors affecting the Gulf of Mexico red snapper population. We begin by noting that red snapper is characterized as a reef fish, and their reef association begins almost immediately after they leave the planktonic stage and settle to the bottom (e.g., Szedlmayer and Howe, 1997; Szedlmayer and Conti, 1999; Workman et al., 2002). This association has been well documented for ages 0–8, but it may weaken considerably at older ages (e.g., Render, 1995; Nieland and Wilson, 2003;

Szedlmayer, 2007). We also note that, on a spatial basis, reef habitat is a relatively scarce commodity in the northern Gulf where red snapper occur (Ludwick, 1964; Parker et al., 1983). In this context, we also examine the issue of habitat limitation (or compensatory mortality) and the life stages at which habitat limitation may be important.

LIFE HISTORY SYNTHESIS

For descriptive and management purposes, we first divide the life history of red snapper into pre-recruit (<50 mm total length, TL) and post-recruit (>50 mm TL) phases. The pre-recruit life stages include eggs, larvae, and post-settlement juveniles <50 mm TL. At 50 mm TL, they enter the Gulf penaeid shrimp trawl fishery as bycatch. The post-recruit life stages include early juveniles (ages 0 and 1), young adults (ages 2 to 7), and mature adults (ages 8+). Early juveniles are taken as bycatch in the shrimp fishery, whereas young and mature adults are taken in the directed fishery.

Pre-Recruit Life Stages

Eggs

Spawning of red snapper in the northern Gulf of Mexico extends from April through September, with peak spawning occurring in June–August (Render, 1995; Bradley and Bryan, 1975; Futch and Burger, 1976; Collins et al., 1996). The eggs are pelagic, spherical, transparent, and about 0.8 mm in diameter (Rabalais et al., 1980). After spawning, the eggs are buoyant and float to the surface. In the laboratory, on the order of 50% of the eggs hatch within 20–27 hr after fertilization (Rabalais et al., 1980; Minton et al., 1983). Gallaway et al. (2007) estimated an egg stage duration of 1 day, with an instantaneous daily rate of natural mortality of $M = 0.4984$ (Table 1).

Larvae

At hatching, the larvae are about 2.2 mm total length (TL), and they remain pelagic until metamorphosis and settlement, which occurs when they are 16–19 mm TL and between 26 and 30 days in age (Rabalais et al., 1980; Szedlmayer and Conti, 1999; Rooper et al., 2004). Gallaway et al. (2007) used a mean larval stage duration estimate of 27 days and an estimated instantaneous daily natural mortality rate for this stage of 0.3014. That estimate is revised herein to reflect a mean larval stage duration of 28 days and an instantaneous daily rate of natural mortality of 0.2413. The estimated total mortality for this stage is $M = 6.7564$ (Table 1).

Lyczkowski-Shultz et al. (2005) showed that larval abundance determined from the SEAMAP (Southeast Area Monitoring and Assessment Program, National Marine Fisheries Service, NMFS) neuston net sampling was directly correlated

Table 1 Life history stages and natural mortality estimates for red snapper over the first two years of life

Age	Stage	Duration	Dates	M	Total	Reference
0*	Egg	1	1 July–1 July	0.4984	0.4984	Gallaway et al. (2007)***
	Larvae	28	2 July–29 July	0.2413	6.7564	Gallaway et al. (2007)
	Juvenile 1	38	30 July–5 Sept	0.1196	4.5448	Rooker et al. (2004)
Totals		*67			11.7996	
0**	Juvenile 2	117	6 Sept–30 Dec	0.0054	0.6318	Szedlmayer (2007)
0/1**	Juvenile 3	181	1 Jan–31 June	0.0054	0.9774	Szedlmayer (2007)
Totals		298			1.6092	
1**	Juvenile 4	365	1 July–31 June	0.0033	1.2	Gazey et al. (submitted)

*Pre-recruit.

**Recruit.

*** M_{egg} values of 13.3 in Gallaway et al. (2007) revised to 11.8 and larval- and juvenile 1-stage durations changed from the Gallaway et al. (2001) estimates of 27 and 39 days to 28 and 38 days, respectively. These changes reflect new data utilized in the methodology described in Gallaway et al. (2007).

with estimates of adult abundance ($r = 0.813$, $p = 0.004$, and $r^2 = 0.661$). Lyczkowski-Shultz and Hanisko (2007) reported occurrence and abundance patterns for red snapper larvae in the Gulf of Mexico. During summer (mid-June through July), the highest mean station abundance values were observed off central and western Louisiana at depths between 50 and 100 m. In addition, red snapper larvae were consistently taken off south Texas, Mississippi, and Alabama, but abundance was lower east of the Mississippi River as compared to areas to the west of the river.

Lyczkowski-Shultz and Hanisko (2007) also observed that abundance from 50- to beyond 100-m depths off central and south Texas in the fall was markedly higher than had been observed in this area during summer. Based upon data from the fall plankton survey, red snapper larvae are encountered much less frequently and in lower numbers in the eastern Gulf than in the western Gulf. Lyczkowski-Shultz and Hanisko (2007) noted that the consistent presence of red snapper larvae in samples taken between the 100- and 200-m depth contours in both the western and eastern Gulf supports the contention that red snapper spawn over a wide depth range, i.e., from mid-shelf to the continental slope.

Post-Settlement Juveniles

We define this stage as early juveniles 19–50 mm TL, 29–66 days in age (Szedlmayer and Conti, 1999; Rooker et al., 2004). Assuming eggs were deposited on July 1 as a start date, these fish would be present for a 38-day period between July 30 and September 5 (see Table 1). Based on Gallaway et al. (2007) and Rooker et al. (2004), the instantaneous daily mortality rate for this stage is estimated to be 0.1196 ($r^2 = 0.918$). The total mortality for this stage would thus be $M = 4.5448$ (0.1196×38 days).

As for most species, natural mortality is high for pre-recruit red snapper (Table 1). The duration of the three pre-recruit stages is 67 days and total $M = 11.8$. Assuming that a 10-

year-old female red snapper produces 69.44 million eggs per year (SEDAR7, 2005), a total of 521 juveniles would survive to 50 mm TL and be susceptible to shrimp trawl bycatch.

Newly settled red snapper quickly move to structured habitat such as low-relief, relic-shell habitat (Workman and Foster, 1994; Szedlmayer and Howe, 1997; Szedlmayer and Conti, 1999; Rooker et al., 2004; Lingo and Szedlmayer, 2006; Piko and Szedlmayer, 2007). These fish grow rapidly in summer and fall and quickly outgrow their initial habitat. As they became larger, they seek larger, more structured habitat (Szedlmayer and Lee, 2004).

Post-Recruit Life Stages

These stages begin with age 0 red snapper greater than 50 mm TL, the size at which they enter the Gulf penaeid shrimp fishery as bycatch. They continue to be taken by this fishery as age 1 red snapper. Red snapper enter the directed fishery at age 2 and are harvested throughout the balance of their lifespan, which can last for over 50 years (Szedlmayer and Shipp, 1994; Render, 1995; Wilson and Nieland, 2001).

Ages 0 and 1

Age 0 red snapper enter the Gulf penaeid shrimp trawl fishery at about 67 days in age and 50 mm TL. Assuming a July 1 start date, they would enter the fishery in early September but would not be fully recruited until they reached about 100 mm TL (Goodyear, 1995). Age 0 and age 1 red snapper densities are highest in the northern Gulf at depths between 18 and 55 m, from the Alabama-Florida border to the Texas-Mexico border (Gallaway et al., 1999). Our review of the NMFS post-1998 observer data file showed that red snapper juveniles are only occasionally taken in the eastern Gulf offshore Florida.

Within the 18- to 55-m depth range in the western Gulf, red snapper settle over all substrates but show an immediate attraction to low-relief, relic shell habitat that provides protection

from predation. This oyster shell habitat provides adequate shelter for new settlers, but as their size increases the fish need larger “hole” sizes for protection. Lingo and Szedlmayer (2006) and Piko and Szedlmayer (2007) conducted *in situ* studies using predator exclusion cages. Shell habitat with predator exclusion cages had significantly more age 0 red snapper than habitat without cages. However, as the fish became larger (>60 mm TL), they moved to concrete block habitat with larger holes and adequate predator protection such that the cage effects were no longer evident.

Szedlmayer and Lee (2004) and Wells (2007) provide strong evidence of an ontogenetic shift from low-relief to higher-relief habitat with size and age. Szedlmayer and Lee (2004) documented a transition in age 0 red snapper from open or low-relief habitat to artificial reefs having relief consisting of 1-m³ concrete blocks. Settlement was observed in July and the newly settled (most <40 mm TL) fish were mostly found over open habitat. At the time of settlement, the reef habitat was occupied by age 1 fish between 100 and 200 mm TL. Age 0 fish began moving onto the reefs as they reached sizes approaching 100 mm TL and by December age 0 fish were found almost entirely on the reefs from which the age 1 fish had abruptly disappeared (Figure 1). Wells (2007), also working offshore Alabama, observed an increase in mean size corresponding to a shift from sand (96.1 mm TL) to low-relief shell (127.0 mm TL) to high-relief habitat (172.3 mm TL).

Szedlmayer and Lee (2004) examined diets of juvenile red snapper between 70- and 160 mm standard length (SL) collected from both reef and non-reef habitat. They observed a diet shift as fish moved from open to reef habitat. The dietary shift reflected feeding more on reef prey than on open-water prey. The shift in habitat and diet suggested differential habitat value based not just on predation refuge but increased access to additional food resources. In contrast, Wells (2007) suggested that red snapper relied on sand- and mud-associated prey regardless of the habitat from which they were collected. However, it is difficult to evaluate this finding because the taxonomic resolution used by Wells (2007) does not appear to be at the level needed to assign the prey species to a specific habitat type.

Once the age 0 fish have occupied reef habitat having sufficient relief and complexity to afford protection from predation and provide additional food resources, they appear to show a high degree of fidelity to these habitats (Workman et al., 2002; Chapin et al., in press). Tagged fish were repeatedly sighted at the same reef over a two-month period, and fish that dispersed as far away as 0.43 km returned to the capture reef within about 25 min. Workman et al. (2002) also observed that the presence of age 1 fish appeared to limit recruitment of age 0 fish to a reef, but as age 1 fish left the reefs, new age 0 recruits were observed. These observations were supported by laboratory studies in which larger red snapper excluded smaller red snapper from reef structures (Bailey et al., 2001).

In summary, larval age 0 red snapper undergo metamorphosis and settle to the bottom in late July at sizes between 16 and 19

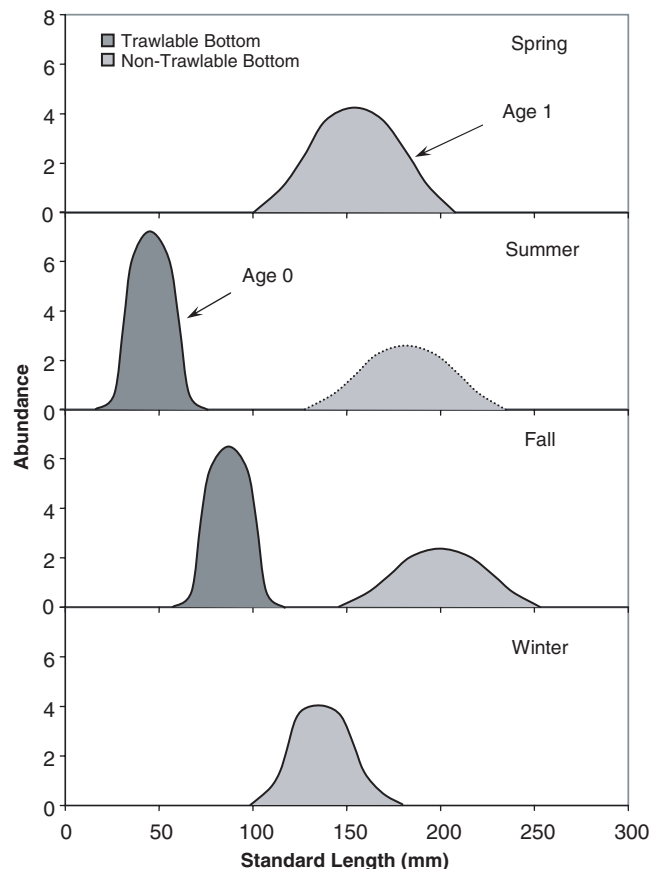

Figure 1 A diagrammatic representation of the shift in distribution of age 0 red snapper (small size group) from trawlable bottom (dark shade) to non-trawlable reefs having intermediate relief (light shade) when age 1 fish move to large, complex reefs in winter. Based on Figure 2 in Szedlmayer and Lee (2004).

mm TL. They are attracted to any low-relief habitat providing cover, but the cover requirements change as the fish grow. Initially, relic shell-ridge habitats are ideal for these small fish, and the greatest known extent of these habitats occur in the mid-shelf zone offshore Alabama (Schroeder et al., 1988; Parker et al., 1992; Schroeder et al., 1995; Dufrene, 2005). In this region, shell-ridge habitat covers about 15% of the sea floor (Dufrene, 2005). Coverage by natural rock reef having greater relief and complexity than relic shell ridges is likely much smaller. Overall, Parker et al. (1983) estimated that 3% of western Gulf mid-shelf seafloor between Pensacola, Florida, and Pass Cavallo, Texas, contained reef habitat, with only 1.6% of this area consisting of reefs having relief > 1 m.

Most age 0 fish move onto reefs with intermediate relief (e.g., 1-m³ structures) by December and appear to occupy these reefs until the following December. At this time, the 18-month-old fish have grown to sizes of approximately 200 mm TL and may require greater relief than is afforded by the intermediate-sized reefs. They begin recruiting to large reefs like natural rock outcroppings, offshore petroleum platforms, and large artificial reefs during their second winter at about 18 months of age (Stanley, 1994; Nieland and Wilson, 2003). In January, these

fish are classified as age 2 fish, even though they are only 18 months old in biological age.

The natural mortality rates for age 0 and age 1 fish are not well documented. Nichols et al. (2005) used the SEAMAP size, age, and abundance data for red snapper in conjunction with shrimp effort data to estimate $M = 0.6$ per year ($SE = 0.36$) for age 1 fish. Assuming $M = 0.6$, SEDAR7 (2005) estimated that F for age 1 red snapper in the western Gulf was 0.62. Thus, total mortality for age 1 red snapper was estimated to be $Z = 1.2$.

The estimate of $M = 0.6$ for age 1 red snapper was used by SEDAR7 (2005) to infer $M = 1.0$ for age 0 based upon the Goodyear (1995) stock assessment, which assumed M for age 1 was 60% of M for age 0. Based on this value of M , SEDAR7 (2005) estimated an age 0 F of 0.52 such that Z_{age0} was 1.52.

However, Wells (2007) estimated instantaneous daily rates of $M = 0.017$ (or more) for age 0 red snapper between age 140 and 200 days that were trawled from a low-relief shell-bed habitat in an area offshore Alabama where commercial shrimp trawling does not occur. Projected to an annual rate, M would be estimated to be on the order of 6.2. Assuming a July 1 start date, this 61-day period would be between November 18 and January 16. This period corresponds to the timeframe when age 0 fish would be moving to high-relief habitat where they are not vulnerable to trawling. We believe the estimates of M derived by Wells (2007) are unrealistically high because they reflect both emigration and mortality.

Szedlmayer (2007) provided diver counts of juvenile red snapper (ages 0 and 1) on artificial shell and shell/concrete block habitat off coastal Alabama for the years 1998 to 2002. When these data are arrayed by year class (Figure 2), estimates of Z ranged from 2.1 to 3.2, averaging 2.6. The habitat stud-

ies were in the artificial reef area off coastal Alabama where commercial shrimp trawling does not normally occur, and the habitats showed no sign that trawling occurred in this area over the life of the study. This suggests most, if not all, of the Z values would consist of M or natural mortality. This estimate of M may also be confounded by not accounting for emigration of fish to larger structures. Overall, Szedlmayer (2007) estimated M for age 0 red snapper to be on the order of 2.0 (1.96), and also suggested higher mortality for stronger year classes than for weaker year classes (Figure 2). Szedlmayer and Conti (1999) observed a similar pattern of increased mortality with more abundant year classes based upon trawl collections from the same region. Collectively, these observations are consistent with the premise that habitat is a limiting factor for juvenile red snapper at observed levels of recruitment.

Gazey et al. (2008) conducted a length-based, age-structured modeling analysis for juvenile red snapper using monthly size and abundance data collected by observers on shrimp vessels. These preliminary results suggest Z for age 0 red snapper appears to be about 2.2, reasonably consistent with the independent estimates of $Z = 2.6$ by Szedlmayer (2007). Both of these estimates are higher than $Z = 1.5$ estimated by SEDAR7 (2005). The Gazey et al. (2008) Z estimates for age 1 fish was 1.3 as opposed to the $Z = 1.2$ used by SEDAR7 (2005). The observer data reflect higher mortality for stronger year classes than for weaker year classes, also supporting the contention that habitat limitation is an important factor governing the dynamics of juvenile red snapper.

Overall, we suggest the best estimate of average M for age 0 fish is 2.0, based largely on estimates from artificial shell and concrete block habitats in areas without trawling (Szedlmayer, 2007), and size and abundance data collected by observers on

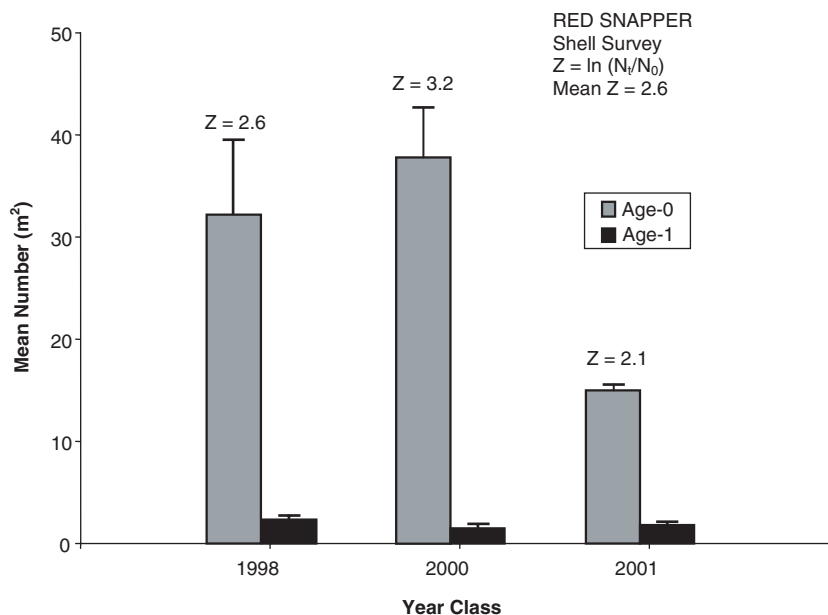

Figure 2 Estimates of annual mortality for age 0 to age 1 red snapper based upon data from Szedlmayer (2007). Samples were taken in the artificial reef area off the coast of Alabama where shrimp trawling does not occur. Thus, Z should consist entirely of natural mortality (M).

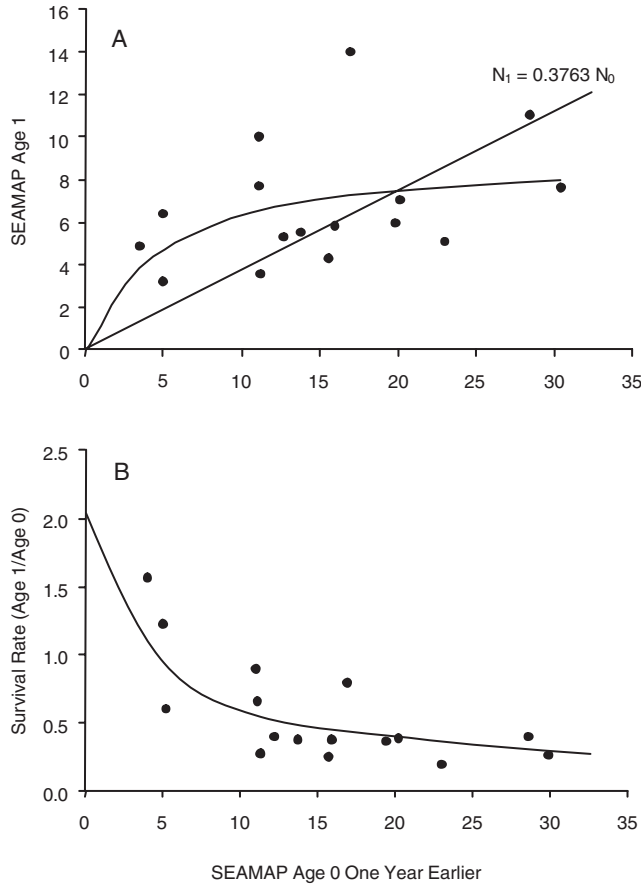

Figure 3 Evidence of density dependence in red snapper mortality rate from age 0 to age 1 is present in the SEAMAP data, when age 0 numbers are used to predict either age 1 numbers the next year (no density dependence would result in proportional response on average, e.g., $N_1 = 0.3763 N_0$) or survival rate to age 1. Note that the appearance of a flat response in Panel A and the decreasing response in Panel B could be due to an errors-in-variables effect; i.e., age 0 measurement errors (Source: SEDAR7 Stock Assessment Report).

shrimp vessels (Gazey et al., 2008). If M for age 0 is about 2.0, as suggested, then following Goodyear (1995) and SEDAR7 (2005), M for age 1 would be 1.2 (0.6×2.0).

The annual natural mortality rates for age 0 = 2.0 and for age 1 = 1.2 equate to daily rates of $M = 0.0054$ and 0.0033 . As shown by Table 1, total natural mortality for age 0 red snapper recruits over the 298-day balance of their first year would be 1.6 and 1.2 for their second year. An estimated 31 of the initial 521 survivors entering the fishery following the pre-recruit stages, as described above, would live to age 2.

SEAMAP data provide evidence consistent with density dependence in red snapper mortality rate from age 0 to age 1 (Figure 3; SEDAR7, 2005). In addition, the results of a stock reduction analysis (SRA) conducted as part of SEDAR7 also suggested that density dependence for these young age groups was occurring (SEDAR7, 2005). Last, shrimp trawl bycatch mortality for juvenile red snapper has undergone a 75% reduction since the 2001–2003 baseline period, yet only moderate (if any) rather than exponential increases in age 1 abundance has

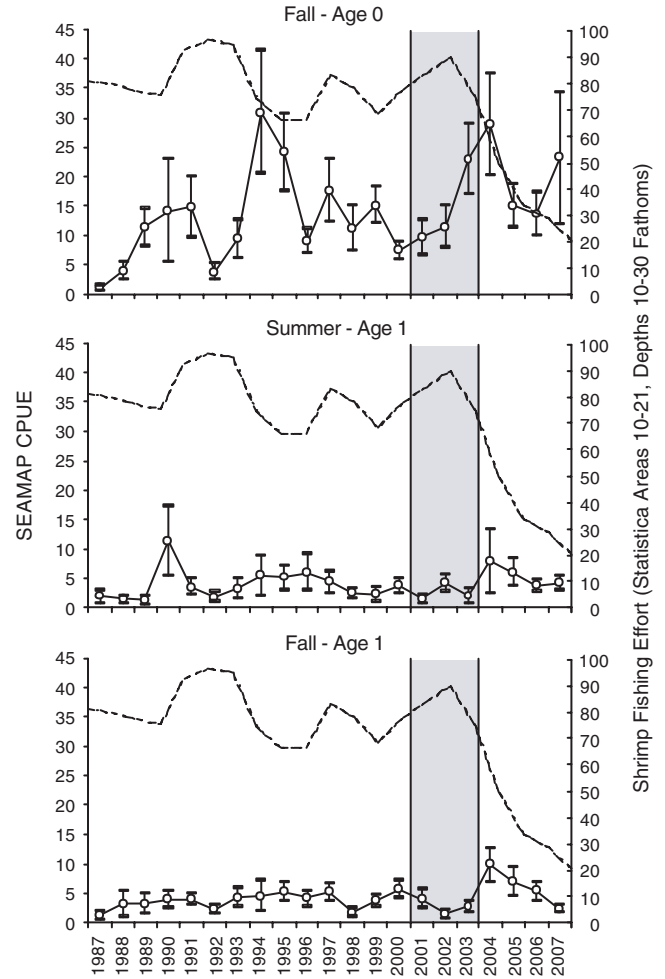

Figure 4 Shrimp fishing effort (nominal days fished, dashed line) from LGL (2007) and juvenile red snapper abundance, 1987–2007, provided by B. Pellegrin, NMFS, Pascagoula Laboratory. Shaded area represents the reference period for evaluating shrimp fishing effort and juvenile red snapper bycatch mortality reductions.

been realized (Figure 4). The combination of habitat scarcity, site fidelity, exclusion of smaller conspecifics from reef habitat by larger fish, and variation in juvenile M with abundance, as described above, suggests habitat is a limiting factor for juvenile red snapper.

Ages 2–7

Red snapper enter the directed fishery at about age 2 and are heavily exploited by directed and recreational fishers for most of their remaining life. They occur across the shelf to the shelf edge and demonstrate an affinity for vertical structures (Patterson et al., 2001a), especially between 2 and 7–10 years of age. They show very rapid growth during the first 8 to 10 years of life (Szedlmayer and Shipp, 1994; Patterson, 1999; Nelson and Manooch, 1982; Patterson et al., 2001b; Wilson and Nieland, 2001; Fischer et al., 2004) (Figure 5). After this period, fish continue to grow but at slower rates. Although still found

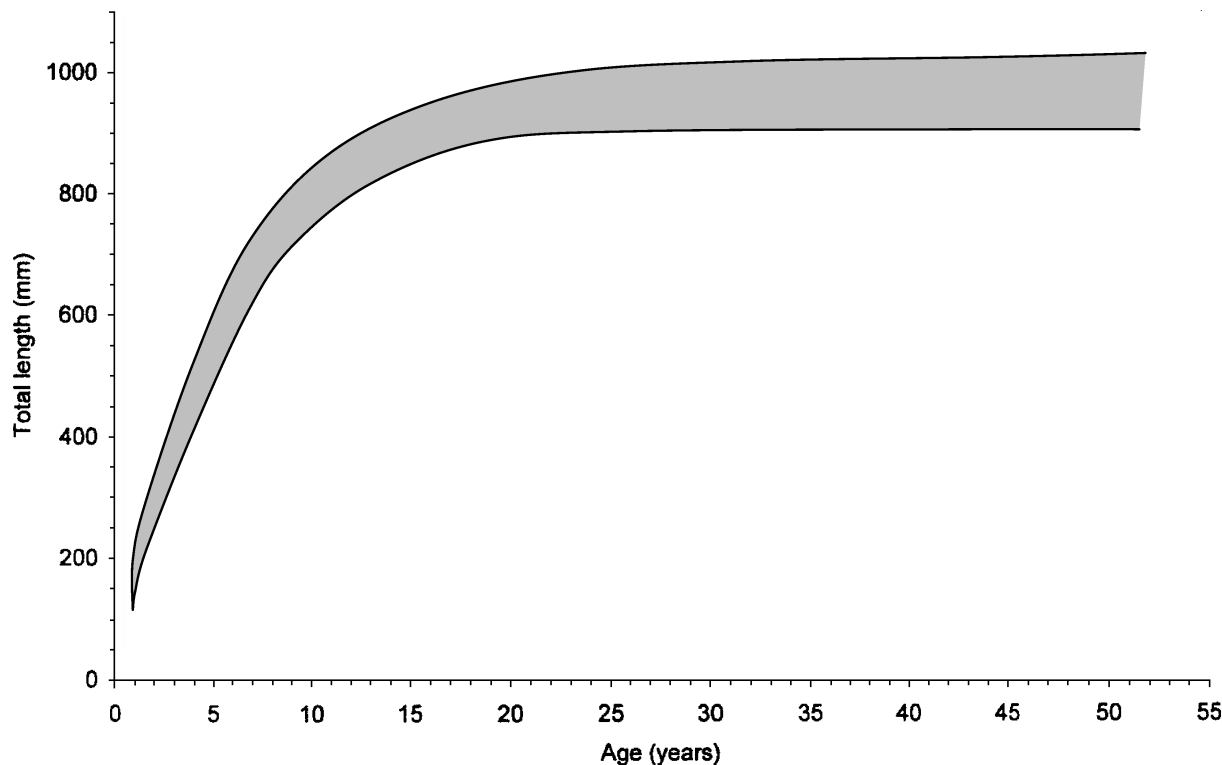

Figure 5 Envelope of von Bertalanffy growth model results for Gulf of Mexico red snapper based upon Nelson and Manooch (1982), Szedlmayer and Shipp (1994), Manooch and Potts (1997), Patterson (1999), and Wilson and Nieland (2001).

on reef structures, these larger fish expand their habitat and may use open areas as well (Szedlmayer, 2007). Because of these differences, we break our discussion into age groups 2 to 7 and ages 8+.

At the beginning of age 2, young red snapper are generally between 200 and 375 mm TL (Goodyear, 1995). It is at these sizes that they enter the directed fishery and recruit to large reefs. These include natural hard substrates with relief on the order of meters, e.g., reef pinnacles, exposed rock ledges, and shelf-edge banks, as well as artificial reefs like offshore oil and gas structures, shipwrecks, and constructed artificial reef areas. Wells (2007) states that “the premise that natural reefs are scarce is a misconception” (103), citing the presence of extensive shell ridges in the north-central Gulf (Schroeder et al., 1995; McBride et al., 1999; Dufrene, 2005) and inner-shelf reef banks and ledges as evidence to the contrary. We disagree with the identification of shell substrate as “reef” habitat. These habitats are actually shifting shell substrates, the distribution of which can change from year to year. They have little similarity to hard limestone reef habitat. In a geological survey, Dufrene (2005) characterized the inner-shelf area offshore eastern Louisiana to panhandle Florida and suggested that this benthic habitat was about 15% shell and 85% soft sand mud substrate. The vast majority of the inner shelf in this area, as well as elsewhere, is composed primarily of sand, mud, and silt, with little or no vertical relief (Ludwick, 1964; Kennicutt et al., 1995).

On a larger spatial scale, Parker et al. (1983) estimated that 2,571 km² of natural reef habitat (3.3% of the bottom) are

present at depths between 18 and 91 m in the region between Pensacola, Florida, and Pass Cavalla, Texas. Of this, only 1.6% (1,285 km²) was comprised of reefs having relief >1 m. Off-shore areas known to contain large natural reefs are protected by the Minerals Management Service (MMS) by imposing “No Activity Zones” around them. In the northern Gulf, the total area of these zones is about 293 km² (Stanley and Wilson, 2003). Most of these areas are outside the depths surveyed by Parker et al. (1983). On a total area basis, natural reef habitat suitable for age 2 to 7- to 10-year-old red snapper is a scarce commodity (1,578 km², 1,285 km² + 293 km²) in the northern Gulf relative to the amount of sand- and mud-bottom habitat.

The primary artificial reef habitats in the Gulf include offshore oil and gas platforms and a 3,108-km² area offshore Alabama within which about 10,000 artificial reefs are present (Minton and Heath, 1998). The footprint areas of the Alabama artificial reefs are typically small, about 9.3 m² on average. Assuming 10,000 structures are presently in place, this would equate to a total area of 23 acres or about 0.1 km² of artificial reef. The northern Gulf of Mexico also contains on the order of 4,000 oil and gas platforms. These structures provide about 12 km² of artificial reef habitat (Gallaway and Cole, 1997). On a spatial basis, the artificial reef contribution to total high-relief reef habitat in the northern Gulf has been small (an additional 12.1 km² to a natural reef area of about 1,578 km²).

In summary, reef habitat with relief on the order of meters constitutes a small fraction of the total shelf area of the western Gulf of Mexico. Considering both natural and artificial reefs, the

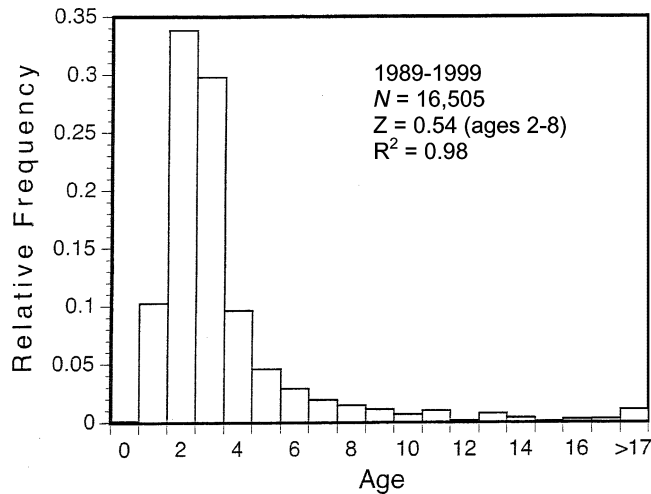

Figure 6 Estimated age frequency of red snapper residing at offshore oil and gas platforms in the northern Gulf of Mexico estimated from fish killed by explosive structure removals (Source: Gitschlag et al., 2003).

total area of reef habitat on the western Gulf shelf is 1,578 km², less than 2% of the total shelf area. The area offshore Alabama where shell substrate habitat comprises an estimated 15% of the bottom area, and there are over 10,000 artificial reefs and numerous oil platforms, is an exceptional area compared to other regions of the northwestern Gulf because it contains relatively large amounts of both juvenile and adult red snapper habitat. Western Louisiana has a large number of offshore oil and gas structures but lacks the vast expanses of juvenile shell substrate habitat that occurs offshore Alabama.

Offshore oil and gas structures and other artificial reefs are, however, used by large numbers of red snapper between ages 2 and 7, and older fish may also occur at these habitats. Explosive removals of these platforms have been monitored and provide a fishery-independent measure of the age structure of resident red snapper (Gitschlag et al., 2003). Red snapper recruit to these habitats as early as age 1 (10%), but the populations appear dominated by age 2 (34%) and age 3 (29%) fish (Figure 6). Age 4 was the only other age group representing as much as 10% of the total population. The red snapper age distribution from these platforms suggested a high rate of total mortality ($Z = 0.54$; Figure 6). Red snapper are known to stratify by size at different depths around platforms in the western Gulf, with smaller fish located higher in the reef than larger fish (Render, 1995). Render (1995) also observed larger individuals to be less obligate in their association with platforms than smaller fish.

Szedlmayer (2007) estimated ages from otoliths for 3,415 red snapper collected from 94 different benthic artificial habitats off coastal Alabama (Figure 7). Age 1 fish comprised about 14%, age 2 (36%), and age 3 fish comprised 25% of the total population (Figure 7). These data also suggested the same high rate of total mortality at artificial reefs ($Z = 0.54$; Figure 7) as shown by Gitschlag et al. (2003).

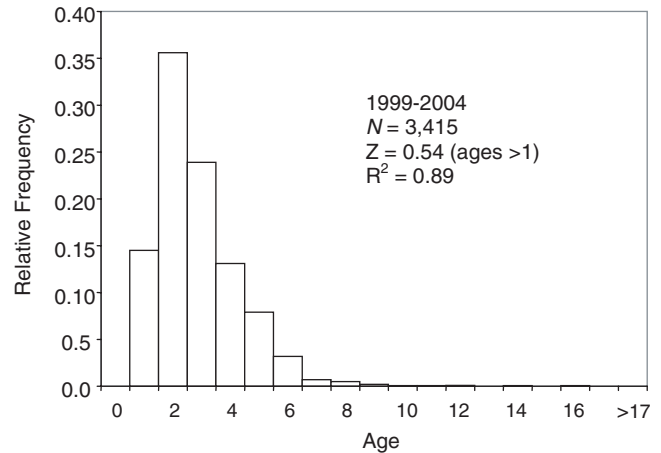

Figure 7 Estimated age frequency of red snapper residing at artificial reefs. Total mortality estimate from fishery independent age frequency distribution in the northeast Gulf of Mexico (Source: Szedlmayer, 2007).

Population Size. Stanley (1994) estimated that, on average, 5,307 (95% CI = 2,756, range 1,200 to 8,200) red snapper occupied each major oil platform offshore of western Louisiana in favorable red snapper habitat during the fall to winter period of 1992. Gallaway and Cole (1997) used this estimate along with distribution and platform size and count data to estimate that the total age 2 red snapper population present at oil platforms in the northern Gulf of Mexico was about 3 million (1.7–4.2 million) fish at the beginning of 1992. This compared to Goodyear's (1995) estimate of 4.2 million age 2 fish in the total red snapper population at the beginning of 1992. SEDAR7 (2005) estimated that the age 2 population size at the beginning of 1992 was about 3.7 million fish. If all these estimates were correct, the observations suggest that 70–80% of the total age 2 population occurred at oil and gas platforms in 1992. If this is true, then the platforms are used by age 2 fish much more than their proportional area would suggest. A possible explanation for such a distribution will be provided below.

Gitschlag et al. (2003) estimated red snapper population sizes at western Gulf offshore oil and gas platforms based on mortality counts associated with the explosive removals of nine of these structures. Results were provided for one platform removed in each of the years 1993, 1998, and 1999; for two platforms in 1994; and for four platforms removed in 1995. The 1995 removals were made during the May–September period and the mean number of red snapper believed to have been residing at these four platforms ranged from 487–1,193, averaging 774.5 (95% CI = 482.2 to 1,066.8). In 1995 there were on the order of 4,000 offshore oil and gas structures in the Gulf, which, multiplied times the average abundance estimated by Gitschlag et al. (2003), yields a total estimate of about 3.1 million red snapper at offshore oil and gas platforms in the western Gulf. Based on Gitschlag et al.'s (2003) age frequency estimates (see Figure 6), about 34% of these (1.1 million fish) would be age 2 fish. In 1995, the total number of age 2 red snapper in the western Gulf was estimated to have been 1.6 million red

snapper (SEDAR7, 2005). Again, approximately 70% of the age 2 red snapper population was suggested to reside at offshore oil and gas structures. Thus, results from at least two independent studies (Stanley, 1994; Gitschlag et al., 2003) suggest that a high proportion of the age 2 red snapper population in the western Gulf of Mexico reside at offshore oil and gas platforms.

Food Habits. The food habits of age 2 and older red snapper in the Gulf of Mexico range from the historical observations of Stearns (1884), Collins (1885), and Adams and Kendall (1891) to present-day investigations. The first comprehensive study of red snapper food habits in the northern Gulf after the turn of the century was reported by Moseley (1966). He collected 712 red snapper stomachs of which 187 contained food. Moseley (1966:96) suggested that red snapper should be considered polyphagous, as both juveniles and adults “ate most anything that was readily available.” On a volumetric basis, fish comprised 44% and 80% of the adult diet at two locations offshore Louisiana and from 40% to 59% of the diet at three locations sampled offshore Texas. Fish comprised less than 50% of the diet in only 2 of the 5 samples and, in each case, the sampled fish had gorged on tunicates, which are seasonally very abundant. Of interest, one of the tunicates (*Distalpia* sp.) was a colonial reef form, whereas the other (*Salpa confederate*) was a free-swimming, pelagic form.

Moseley (1966:98) also observed that red snapper “do not always feed on reef forms,” observing that, in addition to reef species, they fed on prey occurring over soft bottoms rather than at reefs. He noted that the availability of food found in snapper stomachs was probably comparable for mud, sand, and rocky-type habitats. He also observed that, while it appeared that red snapper may have foraged over soft bottoms, it might also be true that motile, soft-bottom prey species were not necessarily confined to sand and mud habitats, but may have ventured onto or near reefs.

Moseley’s (1966) study was followed by red snapper investigations conducted by Bradley and Bryan (1975) offshore Texas. They collected 1,139 snapper at natural reefs along the 40-fm curve from Port Isabel to Galveston, Texas. Of these, 190 contained prey. Fish made up the highest percentage by volume for every season except summer, when the diet was dominated by the swimming crab *Callinectes danae* (39.2%). Bradley and Bryan (1975) also showed extensive feeding on tunicates (13% by number, 21% by volume) in spring samples. They noted that red snapper feed on those items that are most readily available, and the spring blooms of tunicates in some areas provide abundant grazing material. They concluded that fish (other than eels) constituted the primary food each season, and other important foods included eels, mantis shrimp, and rock shrimp in spring; crabs and rock shrimp in summer; and eels in winter.

Red snapper diet studies were conducted in the eastern Gulf offshore Florida by Beaumariage and Bullock (1976) and Futch and Bruger (1976). In this part of the Gulf, invertebrates appeared more important than fish in the diet of red snapper. The Florida shelf habitat is markedly different than the shelf habitat of the western Gulf (Alabama to Texas) based on oceanic

currents, freshwater discharge, sediments, and biota (Gallaway, 1981).

Gallaway et al. (1981) characterized the food habitats of red snapper at the Buccaneer Gas and Oil Field platforms located offshore Galveston, Texas, at depths of about 10 fathoms. They suggested that red snapper moved away from the platforms during the late night to early morning period to feed over soft bottoms. Hastings et al. (1976) obtained similar results for lutjanids at research platforms in the northeastern Gulf. Peabody and Wilson (2006) also suggested that nocturnal movements of red snapper away from Louisiana platforms was related to feeding behavior.

Ignoring squid, which was used for bait, Gallaway et al. (1981) reported that the gut contents of red snapper in winter contained mainly fish (small carangids, mainly the platform-associated rough scad). In spring, the diet was dominated by mantis shrimp (69%), and in summer the diet was dominated by fish (unidentified fish 23.5%, Atlantic cutlass fish 19.3%, and carangids, probably scad, 18.6%) and mantis shrimp (29.5%). In fall, crustaceans (shrimp 53.2% and crabs 17.2% for a total of 70.4%) and fish (26.6%) dominated the diets. Clearly, soft-bottom prey were a major component of the diet, but reef-associated fish were taken when abundant.

Siegel (1983) described red snapper food habits for habitats sampled offshore Alabama and some samples from Louisiana and Florida. For adults, fish and crabs constituted the main part of the diet. Of interest, all sizes of adults were noted to consume crabs, rock shrimp, penaeid shrimp, larval decapods, and larval mantis shrimp.

Ouzts and Szedlmayer (2003) examined the diets of red snapper collected from the artificial reef area offshore Alabama among four diel feeding periods (dawn, day, dusk, and night) and among three standard-length size classes: small (200–299 mm SL), medium (300–399 mm SL), and large (400–499 mm SL). A total of 432 stomachs were examined, of which 164 contained prey. Prey items were assigned a habitat association based upon the literature, personal observations made by the authors, and consultations with experts on the prey group in question. Small red snapper fed mostly on reef and sand prey types; medium red snapper fed on similar portions of reef, sand, and mixed habitat prey types; and large red snapper fed mainly on prey observed to use a variety of habitats. Red snapper were indicated to feed throughout the 24-hr cycle, with mean gut fullness being significantly lower at dusk than for the day period. Fish were the dominant prey throughout the 24-hr cycle. The second-most important prey group changed with period: shrimp were codominant for dawn, tunicates for day, and crabs were codominant for dusk and night periods.

The Szedlmayer and Lee (2004) food habitat studies of red snapper from open bottom and artificial reefs offshore Alabama were dominated by juveniles <200 mm SL as described above. However, 61 specimens were collected from reefs that ranged from 200 to 250 mm SL. For these fish, the principal prey categories on a volumetric basis were fish (59.7%), shrimp (27.8%), and crabs (12.5%). For the fish-prey category,

approximately 65% were reef-associated taxa, including blennies (37.7%), *Halichoeres* sp. (13.0%), Serranidae (9.0%), *Serranus* sp. (2.9%), and *Centopristes* sp. (2.3%). The dominant “shrimp” taxa in the large red snapper stomachs included mantis shrimp (42.4%), rock shrimp (29.3%), Alpheidae (13.4%), Hippolytidae (11.5%), and unidentified shrimp (3.4% of the total shrimp component).

Szedlmayer and Lee (2004) classified rock shrimp, Alpheidae (pistol shrimp), and Hippolytidae (cleaner shrimp) as reef-associated taxa and mantis shrimp as open-bottom residents. On this basis, reef shrimp constituted 54.2% of the shrimp eaten as compared to 42.4% that were from open-bottom habitats. Rock shrimp have been treated as open-bottom species by other investigators. This species is most abundant on hard mud and/or shell substrates (NOAA, 1985). Offshore Alabama, the high density areas for rock shrimp mapped by Darnell et al. (1987) generally correspond to the area of shell-ridge or “ragged bottom” habitats described above, thus the reef designation by Szedlmayer and Lee (2004). However, this species is not typically found in high numbers on reefs having high vertical relief like that used by adult red snapper. If one treats rock shrimp as an open-habitat organism, approximately 72% of the shrimp in the diet of red snapper come from open bottoms as compared to about 25% from reefs, mainly pistol and cleaner shrimp.

The Szedlmayer and Lee (2004) data indicate that red snapper in the 200–250 mm SL length range on artificial reefs offshore Alabama fed on both reef and open habitat prey types. Even if all crabs and all the shrimp but pistol and cleaner shrimp are treated as soft-bottom species, reef prey still constituted about 46% of the total diet based upon this data set.

McCawley and Cowan (2007) evaluated red snapper food habitats for fish from the Alabama artificial reef area that were mainly caught by recreational fishermen between May 1999 and April 2000. They examined 656 red snapper stomachs, of which 268 contained prey. The empty and bait-only stomachs were excluded from further analyses. The fish with prey ranged from 240–913 mm fork length (FL) (mean = 463 mm FL). On an average percent weight basis, unidentified material contributed the largest proportion to the observed diets (35.9%) followed by crab (20.2%), fish (19.5%), adult mantis shrimp (12.6%), and pelagic zooplankton (8%). McCawley and Cowan (2007) also recalculated the mean% weight values after removing the unidentified material from the analyses. On this basis, fish dominated the diet (28.7%), followed by crabs (26.8%), pelagic zooplankton (23.5%), mantis shrimp (16.1%), and miscellaneous benthic species (2.2%).

McCawley and Cowan (2007) estimated only 1.3% of the red snapper diet (excluding unidentified material) consisted of reef-associated organisms, 1.3% of the diet consisted of *Sargassum*-associated species, and 0.7% consisted of species occupying a variety of habitats. In contrast, the dominant components of the diets were species associated with sand and mud habitats (41.2%) and the water column (31%, mainly larval mantis shrimp and larval fish). Their interpretation of these data was

that adult red snapper were almost, if not entirely, trophically independent of the reefs on which they lived.

McCawley et al. (2006) collected diel food habitat data for red snapper in the Alabama artificial reef areas in July and August 2000. A total of 109 red snapper stomachs were collected from fish 295 to 560 mm FL (mean = 382 mm FL). Of these, 46 contained prey. When examined on a diel basis, red snapper appeared to feed throughout the day and night, with no obvious pattern in feeding periodicity. Unidentified material was the dominant food category in both day (35.1%) and night (31.4%) periods, followed by fish (34.7% day and 30.6% night), crabs (12.7% day and 12.2% night), and rock shrimp (10.4% day and 9.3% night). Mantis shrimp were not observed in stomachs collected during the day but comprised 9.4% by weight in the night samples. Once more, over half of the fish and crab category consisted of unidentified specimens. McCawley et al. (2006) concluded that less than 2% of the red snapper diet came from reef-associated organisms based upon the defined habitat associations of the identified prey organisms.

In summary, red snapper appear to be opportunistic feeders that feed throughout the day and night. They have been documented to feed on abundant swarms of water column organisms like pteropods and free-swimming tunicates when these occur, as well as on fish, crabs, and shrimp from surrounding soft bottoms, and on reef-associated fish, crabs, encrusting tunicates, and shrimp. However, more accurate estimates of the relative proportions of their diet derived from different habitats are needed. It is clear, however, that many studies show substantial feeding on reef prey types, which supports the contention that red snapper are obtaining significant food resources from reef habitats.

Site Fidelity. The degree of movement and/or site fidelity shown by red snapper in the young adult age group has been addressed by historical and recent studies. Beaumariage (1969) tagged and released 312 red snapper off the coast of Florida and reported a return rate of 26%. All but eight of these were reported to have been recaptured at the release site after being at liberty for an average of 113 days. These data indicated a high degree of site fidelity (>90%) over at least the short term (113 days or about 3.8 months). Beaumariage and Bullock (1976) also reported that red snapper in shallow water showed a high degree of site fidelity and that the only extensive movements occurred in water deeper than 15 fathoms.

Fable (1980) tagged 299 red snapper at natural reefs off the coast of Texas and 17 fish were recaptured. Of these, 16 were recaptured at the release location, and one that had been at liberty for 162 days, or about 5 months, had moved 5 km. Gallaway et al. (1981) reported very high short-term fidelity for red snapper at platforms in the Buccaneer Gas and Oil Field offshore Galveston, Texas, over the summer months. All of the tags returned by fishermen or noted during visual SCUBA census were found at the site where the fish had been released. However, fishing pressure was intense in the Buccaneer Oil and Gas Field, and most of the entire annual recruitment was estimated to have been harvested each year.

Several other mark-recapture studies have been conducted at artificial reefs offshore Alabama. Szedlmayer and Shipp (1994) tagged and released 1,155 relatively small red snapper (mean \pm SE = 287 \pm 0.9 mm TL; size range 177–410 mm TL). A total of 146 tagged fish were recovered, but only 37 of these had known recapture locations. A total of 27 (74%) of these fish were recaptured within 2 km of their release site, and 21 of these were caught in the immediate vicinity of their release location. The greatest distance moved by an individual fish was 32 km, and distance moved was not related to time at large (see Figure 6 in Szedlmayer and Shipp, 1994). These data were interpreted to suggest a high degree of site fidelity.

Watterson et al. (1998) reported results of a red snapper mark-recapture study conducted off the coast of Alabama from March 1995 to January 1997. Nine artificial reef sites, with three each being placed at 21-, 27-, and 37-m depths, were constructed 18 months prior to the start of the study. A total of 1,604 fish were tagged between March 1995 and October 1996. The tagged fish had a mean TL (\pm SE) of 336 mm (\pm 1.84), and 80% were less than 400 mm TL. The majority of these fish were 3-year-olds or less. A total of 167 individual fish were recaptured. Hurricane Opal passed within 40 km of the reef sites in October 1995, about eight months into the study. Eighty percent of recaptured red snapper that were not at liberty during Opal were recaptured at their site of release, suggesting strong site fidelity. Fish that were at liberty during Opal showed greater movement. They had a significantly higher likelihood of movement away from their site of release and moved far greater distances than fish not at liberty during Opal. The at-liberty fish moved an average of 32.6 km, with eight fish moving over 100 km and three fish moving over 200 km. The fish not at liberty during Opal moved much shorter distances, from 1.7 to 2.5 km. Clearly, Hurricane Opal affected the movement and site fidelity of the fish.

Patterson et al. (2001a) continued the mark-recapture study of Watterson et al. (1998) through August of 1999. Another strong hurricane occurred during the extended study. Hurricane George passed within 50 km of the reef sites in September 1998. In total 2,932 red snapper were tagged, with 2,053 released at their capture site and 879 released at locations other than their capture site. Mean TL (\pm SE) of these tagged fish was 335.1 \pm 1.34 mm; thus, most were age 3 or less. Overall, 519 individual fish were recaptured, with 193 recaptured on tagging trips and 326 recoveries made by fishers. Of the fish recaptured at tagging sites, 188 (97%) were captured at the site where they had been released while five had changed location.

Location of recapture was reported for 232 recoveries reported by fishers (Patterson et al., 2001a). Mean time at liberty was 404 days, which was 2 to 3.5 times longer than the mean time at liberty for recaptures from previous studies. Of the fish recaptured by fishers, 36% were captured within 2 km of the release site. One fish, which had been at liberty for 598 days, moved 352 km to the east; another, which had been at liberty for 1,367 days, moved 259 km southwest of its release site. In contrast, the maximum time at liberty for a tag recovery by fishers was 1,501 days, and this fish was caught only 3.5 km from

its release site. The mean vector of reported movement was 42.4 km to the east for individuals at liberty during hurricanes and 7.4 km to the east-northeast for individuals not at large during the two hurricanes. The movement observed by Patterson et al. (2001a) was greater than had been previously reported for red snapper in the northern Gulf.

Patterson and Cowan (2003) used the data described by Patterson et al. (2001a) to estimate site fidelity by modeling the decline in recaptures at the tagging sites over time to obtain an annual instantaneous rate of decline or D (daily rate \times 365 days). This value would be equal to the sum of total annual instantaneous mortality (Z) and total annual instantaneous emigration defined as Q . The authors assumed that no fishing mortality occurred at the site and calculated M following Royce (1972) and Hoening (1983). These approaches yielded M estimates of 0.0868 and 0.0855, or an average of 0.08615. Once D and M (or Z) were calculated, Q was obtained by subtraction. Site fidelity (SF) was estimated as e^{-Q} . Estimated SF values ranged from 24.8% for all recaptures to 25.3% for all recaptures of fish that were released at their original capture location, to 26.5% for recaptures for fish tagged and recaptured in the intervals between hurricanes.

The above estimates of SF assumed that all tagged fish were recognized. However, these authors also recognized in an earlier publication that tag shedding occurs (Patterson et al., 2001a), but did not account for this tag shedding in their latter SF estimations. For example, the estimated 95% confidence interval for probability of tag retention for a fish at liberty for 200 days was 0.87–0.96, but for a fish at liberty for 755 days, the 95% confidence interval for probability of tag retention was only 0.05–0.37. We suggest that a major component in the decline in recapture fish was related to tag shedding, and this factor needs to be accounted for in SF estimation.

The estimates of $Z = 0.09$ (or M , since no fishing was believed to have occurred) are highly conservative for the age of the fish in question. As described above, Szedlmayer (2007) estimated ages from otoliths for 3,415 red snapper collected from 94 different artificial habitats offshore Alabama (see Figure 7). Based upon these data, Z for ages 2 to 16 was estimated to be 0.54. If this Z value is used, $Q = 0.93$ and SF would be on the order of 40%, which is still low as compared to historical studies.

Two additional studies have used conventional mark-recapture methods. Strelcheck et al. (2007) tagged 4,317 red snapper at 14 experimental artificial reefs off coastal Alabama between January 1999 and October 2002. Mean length at tagging was 335 mm TL (\pm 63.3 mm SD). Some 629 recaptures were reported, of which 412 (65%) were made by the researchers at the original release site, and 217 recaptures were reported by fishers. Mean time at liberty was 401 days, with a range of 1 and 1,587 days. Most fish (86%) showed little movement, 2 km or less, from the release site. Mean and maximum distances moved were 2.1 km and 201 km. The mean dispersion rate from release sites was 8.6 m day⁻¹. Annual SF estimates were made following Patterson and Cowan (2003) and ranged from 48 to

52%. If Z for this area is 0.54 (Szedlmayer, 2007), SF would be estimated to be above 75%.

Strelcheck et al. (2007) concluded that the observations of high SF and low dispersal rates provided support for the hypothesis that artificial reefs offshore Alabama provide suitable habitat for adult red snapper. However, they suggested the ratios of instantaneous growth ($G = 0.54$) in weight to total mortality ($Z = 0.7$ to 0.9) were <1 , indicating that the reefs off Alabama were not producing new biomass at current fishing mortality rates. In contrast, if $Z = 0.54$ (Gitschlag et al., 2003; Szedlmayer, 2007) was used, the G/Z ratio would be equal to 1.

In another conventional mark-recapture study, 5,614 red snapper were tagged between July 2002 and August 2005 (Diamond et al., 2007). Tag returns provided location information for 82 fish. Of these, 54% moved an average distance of 20.4 km. In the second program, over 9,000 fish were tagged by "Fish Trackers" (research personnel, volunteer anglers aboard charter headboats, and private boats) between 1983 and 2006. In that study, 60 returns were analyzed for movement. Most (72%) were recaptured at their release site, with 28% showing an average movement of 19.1 km. Diamond et al. (2007) concluded that the spatial scale of movements in this study was small enough to support the idea that red snapper stocks in the northern Gulf are relatively isolated and that there may be a separate demographic stock off Texas. Similarly, genetic studies have indicated that red snapper in the Gulf maintain a complex of semi-isolated populations in which relatedness is maintained over geologic time by gene flow, yet the populations are demographically independent over the short term (Gold and Salliant, 2007). Thus, all of these later studies (Strelcheck et al., 2007; Diamond et al., 2007; Gold and Salliant, 2007) support the view of limited movement and relatively high SF.

While there have been extensive mark-recapture studies of red snapper as described above, they all have the inherent difficulty of reliance on private fishers for accurate positional information for recaptures. Positional information from private fishers, especially for red snapper, is unreliable at best, and can only be counted on to add variance to SF estimations. This issue of confidence about positional information from private fisher returns has prompted a number of ultrasonic telemetry studies (Szedlmayer, 1997; Szedlmayer and Schroepfer, 2005; Schroepfer and Szedlmayer, 2006; Peabody and Wilson, 2006). Szedlmayer (1997) reported residence times on artificial reefs of 17–597 days, and Szedlmayer and Schroepfer (2005) estimated red snapper were resident on an artificial reef for a mean of 212 days, with an individual fish staying at one reef for up to 597 days. Using the previously published information along with new ultrasonic tagging studies, Schroepfer and Szedlmayer (2006) used event analysis described by Allison (1995) to provide a newer estimate of residence time on reefs. Fish were larger than previous studies (mean \pm SD = 518 \pm 140, range 301–840 mm TL, $n = 77$), which may account for some of the differences from previous conventional tagging studies. In this later study, however, the median residence time increased to 373 days or about one year.

Peabody and Wilson (2006) released 125 red snapper with acoustic transmitters at oil platforms arrayed in a circle around a salt dome about 50 km south of Port Fourchon, Louisiana. The mean size of these fish was 360 mm TL, and the range in length was 280–470 mm TL. Remote receivers were deployed on the platforms at 10–20 m depths and on artificial reefs within the circle of platforms. They detected 97 of 125 tagged red snapper released with transmitters. The majority (94%) of the tracked red snapper showed no movement between receiver locations on a daily, weekly, or monthly basis. There were 36 recaptures from fishers, with most (81%) captured at their release site. Seven recaptures were reported at locations other than their release site. Days at liberty for these seven fish ranged from 5 to 130 days, and distance traveled ranged from 2 to 25 km, but again, these reported recapture locations are subject to the same error as conventionally tagged red snapper. Peabody and Wilson (2006) estimated a maximum estimate of SF for six months was 90%. Assuming constant emigration rate over the next six months, they projected the annual SF would be 80%.

The higher estimates of SF obtained by Szedlmayer and Shipp (1994) and Strelcheck et al. (2007) as compared to the lower estimates of Watterson et al. (1998) and Patterson et al. (2001a), all working in the same general area off coastal Alabama, may be explained, in part, by the differences in the artificial reefs at the study sites. Reefs used in the Patterson et al. (2001a) studies were largely constructed of 55-gallon drums and newspaper dispenser machines, whereas the reefs used in the other studies were considerably more substantial (e.g., concrete tetrahedrons, concrete mats over pipelines, etc.). The small artificial reefs used by Watterson et al. (1998) and Patterson et al. (2001a) may have been more altered or dispersed by storms and hurricanes compared to the larger more stable artificial reefs used by Szedlmayer and Shipp (1994) and Strelcheck et al. (2007).

The natural mortality rate for age 2–7 red snapper may be higher than is the case for older fish. At present, it is assumed that $M = 0.1$ for age 2+ red snapper; i.e., this value is assumed to be constant across all ages from 2 to 53 (SEDAR7, 2005). We suggest that it is more reasonable to assume, based upon growth and habitat use patterns for young versus older fish, that natural mortality is higher at age 2–7 compared to fish greater than age 7. We also suggest that, given the scarcity of reef habitat and the relatively high estimates of SF, habitat limitation is a significant factor governing the dynamics of age 2–7 red snapper.

Age 8+

As described above, red snapper grow rapidly over the first 8 to 10 years of life, after which growth slows (e.g., Fischer et al., 2004; see Figure 6). During this timeframe, snapper take up residence on structured habitat, and as the fish grow larger, there is an ontological shift to reef habitats with greater vertical relief and complexity. The reefs may provide protection from

predation and increased prey resources (Szedlmayer and Lee, 2004; Piko and Szedlmayer, 2007). Small and intermediate (up to about age 10) red snapper show greater SF to reefs compared to the largest (greater than age 10) red snapper (Render, 1995; Szedlmayer, 2007). The most plausible explanation for these changes in SF is that older fish (age 8–10) reach sizes that render them largely invulnerable to predation, and they may spend a larger portion of their time over soft bottoms, especially areas with sea bottom depressions and lumps, etc. (Boland et al., 1983; Render, 1995; Nieland and Wilson, 2003).

In 1999, the National Marine Fisheries Service (NMFS) initiated an offshore bottom-longline survey designed to address the abundance, size, and age distribution of red snapper across the shelf of the Gulf of Mexico (Mitchell et al., 2004). Pilot studies were conducted in 1999 and 2000, sampling in two areas at depths between 64 and 146 m. In 2001, the annual longline survey was expanded to cover depths between 9 and 366 m (or 5 and 200 fm) across the entire Gulf. The longline sets were randomly located, stratified only by depth and longitude rather than by habitat.

Red snapper catches varied geographically and with depth (Mitchell et al., 2004). Only 12 red snapper were caught at the 269 stations east of the Mississippi River as compared to 232 snapper caught at the 324 stations sampled west of the Mississippi River. Differences in age and size of fish were also observed, with older, larger red snapper found in the western Gulf (up to 53 years in age, median 12 years, and median TL = 784 mm) and younger, smaller fish found in the eastern Gulf (up to 19 years old, median age of 6 years, median TL of 625 mm). Red snapper were most abundant at depths ranging from 55 m to 92 m, with catches declining both inshore and offshore of these depths (Mitchell et al., 2004).

The relative age distribution observed in these studies (see Figure 5 in Mitchell et al., 2004, summarized herein by Figure 8) showed that red snapper were fully recruited to the longline gear at age 8. Abundance declined from these levels in a linear fashion

through age 22 and remained relatively consistent thereafter. The populations of red snapper vulnerable to longline fishing over soft bottoms appears to consist of fish larger than those that occur around reefs (compare Figures 6, 7, and 8). One explanation is that once the fish reach 8 to 10 years of age, they are no longer totally dependent upon structured habitats and can forage over open habitat with little threat from predation.

The prohibition of longline fishing inside of 92 fm in the western Gulf likely has been one of the most significant management actions taken by the Gulf of Mexico Fisheries Management Council (GMFMC). In some areas, large numbers of large fish may be dispersed over open habitat where they are not highly vulnerable to vertical line fishing. However, they can be efficiently harvested using longlines (e.g., Prytherch, 1983). This soft bottom pool of fish is now protected.

DISCUSSION

Site fidelity provides an annual estimate of reef fish immigration or emigration from a reef. For red snapper, 2- to 3-year-old fish at artificial reef structures in shallow water show high fidelity to a site on temporal scales of months to a year, albeit the probability of detecting ultrasonically tagged red snapper at a site one year after release was only 50% (Schroepfer and Szedlmayer, 2006). Diamond et al. (2007) provided a list of factors that have been suggested to be important in affecting the percentage of fish that move compared to the percentage of fish that remain at a site. These included size or age of fish (Moseley, 1966), depth of capture (Beaumariage, 1969; Watterson et al., 1998), seasonal patterns due to water temperature or reproductive condition (Topp, 1963; Beaumariage and Bullock, 1976), hurricanes (Watterson et al., 1998; Patterson et al., 2001a), and translocation from the tagging site (Watterson et al., 1998; Patterson et al., 2001a; Peabody, 2004). The accuracy of positional data reported for tag returns by fishers can also be an issue regarding SF.

It has also been hypothesized that SF of reef-associated organisms is dependent both upon prey availability and the availability of suitable refuge, i.e., the resource mosaic hypothesis (Lindberg et al., 1990; Frazier and Lindberg, 1994) and density-dependent habitat selection (Lindberg et al., 2006). Reef-associated fish species that rely on benthic prey as the primary component of their diet may create a gradient of prey depletion (or feeding halo) around the reefs, resulting in negative feedbacks to reef fish energetics, residence times, and local abundance, particularly when the feeding halos of adjacent reefs overlap (Lindberg et al., 2006). The degree of prey depletion and associated negative feedback can alter the potential for sustained productivity of an artificial reef or reef complex. Bioenergetic demands increase as foraging area increases, resulting in increased emigration from resource-depleted reefs to reefs containing a greater abundance of prey.

In contrast, reefs or reef complexes that can sustain prey resources over time may potentially benefit reef fishes and fishery

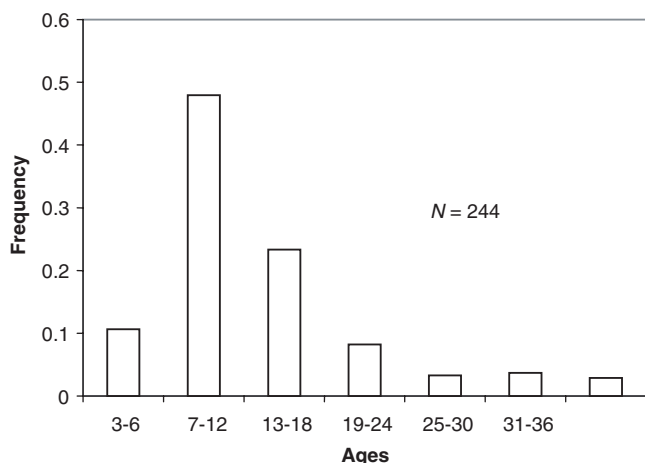

Figure 8 Age frequency of red snapper caught during NMFS research longline surveys from 1999 to 2002 in depths of 9–366 m (Source: Mitchell et al., 2004).

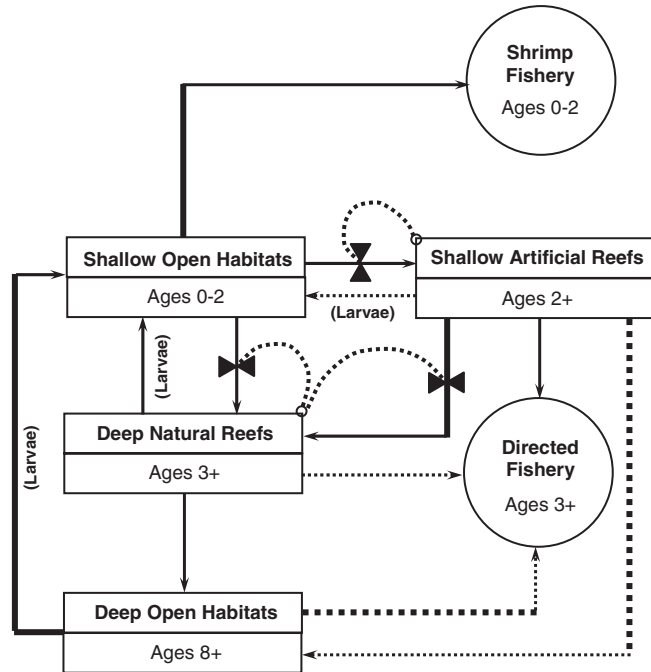

Figure 9 Conceptual model of habitat use by age of red snapper. The fishery is heavily dependent on young fish inhabiting artificial reefs.

production by reducing the costs of foraging, increasing growth rates, and increasing SF. Under these conditions, the fish would tend to show less movement during foraging due to increased risks of predation and reduced proximity to shelter (Strelcheck et al., 2007). However, if reef densities are high in an area, the distances between them are shorter, and reef fish may move among these habitats more readily than they would otherwise, resulting in increased movement and an expanded home range.

Red snapper in clustered habitats may be able to explore nearby alternative habitats with very little cost.

Mark/recapture studies support the idea that movement occurs on two scales. Large-scale climate events such as hurricanes increase the proportion of fish that move and the distances that these fish move. On the other end of the spectrum, many fish may move but only for distances of a few kilometers. These observations are well illustrated by Figure 1 in Strelcheck et al. (2007). Diamond et al. (2007) observed that almost all red snapper will relocate at some time during their lives if they survive long enough. They also noted, however, that the scale of movements they observed supported the hypothesis that, on a geographic basis, red snapper stocks in the northern Gulf are relatively isolated, with periodic long-range dispersement caused by hurricanes or some other factor that triggers long-range movements. They interpreted their data from Texas to be consistent with the idea of a separate demographic stock off Texas, as implied by Fischer et al. (2004) and Salliant and Gold (2004).

Once red snapper grow to about 8 years old, they are large enough to be invulnerable to most predation and occur over open habitat as well as at reef habitat. In the western Gulf, these fish are most abundant in longline sets at depths between 55 and 92 m (Figures 9 and 10). In this region, the zone of highest abundance of early larvae corresponds to the distribution of 8+ year adults taken by longlines (Figure 10). However, spawning is also known to occur across the shelf. The eggs and larvae are planktonic for about one month and then settle to the bottom as early age 0 fish. The natural mortality during this period is high, on the order of $M = 11.8$ (see Gallaway et al., 2007).

Although spawning occurs over most of the shelf, the age 0 new recruits are most abundant at depths between about 18

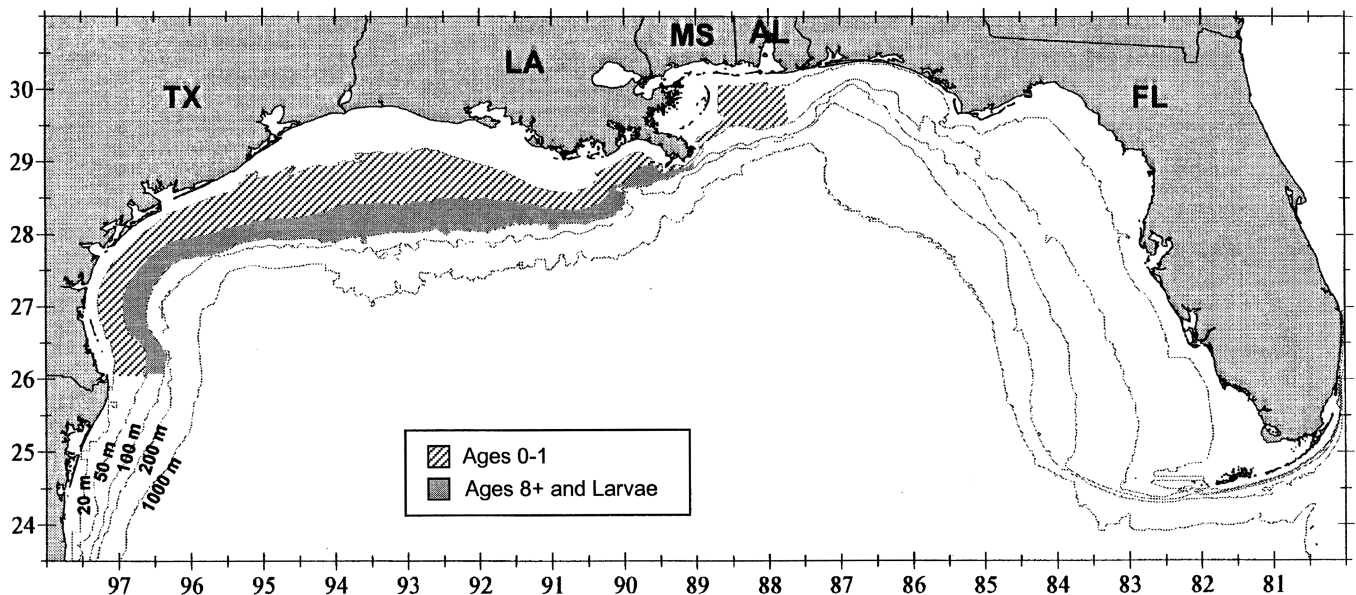

Figure 10 Distribution of age 8+ red snapper (based on Mitchell et al., 2004), red snapper larvae (based on Lyczkowski-Shultz and Hanisko, 2008), and age 0-1 red snapper (based on Gallaway et al., 1999). These data suggest spawning mainly occurs in the western Gulf at depths between 50 and 100 m, and that the larvae are transported toward shore and settle at depths between 20 and 50 m.

and 55 m (Figure 10). Initially, they are abundant over all substrates but quickly become aggregated at low-relief habitats like relic oyster-shell beds (relief in cm), which affords protection from predation. As the fish grow, the degree of protection from predators provided by low-relief habitats diminishes, and they become large enough to be taken as bycatch in the shrimp fishery. Bycatch losses are greatest during the period from October to December.

By December, fish are able to occupy larger reefs (vertical relief about 1 m), which become vacant when their previous occupants (age 1 red snapper) move to reefs with even greater relief. The age 0 fish occupy these reefs from December of one year to December of the next year. All of the evidence is consistent with the premise that habitat is a limiting factor for age 0 to age 1 fish, as described above. The evidence includes habitat scarcity, site fidelity, exclusion of smaller conspecifics by larger fish, and variation in *M* with abundance.

Fish tend to move to larger artificial reefs as late age 1 or early age 2 fish. At offshore oil and gas platforms in the western Gulf, the younger, smaller fish occupy the upper water column, and larger, older fish occupy the deeper areas of the reefs. Offshore petroleum platforms may be particularly valuable because they provide shelter and feeding opportunities throughout the water column. The fish at artificial and natural reefs are known to forage on reef prey types but also forage away from the reefs, and small fish feed on water column prey as well. Small and intermediate fish at artificial reefs in shallow water (<50 m) show the highest degree of SF. Sometime after about age 8, red snapper begin to show less dependence on structured habitat and can also be found over open habitat. We suggest that this is essentially a size refugia, enabling them to spend greater amounts of time over benthic foraging grounds.

Other than the large shelf-edge banks and features like the pinnacle region off coastal Alabama, little is known about the distribution and spacing of natural reefs in the northwestern Gulf. As compared to natural reefs, artificial reefs are relatively small and occur in two main clusters: (1) oil and gas platforms off central and western Louisiana, and (2) the extensive artificial reef zones off Alabama. Off Alabama, the artificial reefs are clustered within specifically permitted artificial reef areas. The offshore platforms also occur as closely spaced clusters of platforms representing individual oil fields. Most of the artificial reefs are located in water <100-m deep, in the same zone where age 0 and age 1 fish are most abundant. Parker et al. (1983) noted that depths between 91 and 183 m in the Gulf were not surveyed for the presence of natural reefs because of gear and time constraints. They also noted that these depths were already known to contain "prime reef fish habitat and probably contribute significantly to the total amount" (Parker et al., 1983:937). However, the MMS designation of no activity zones to protect known reefs suggests the total area of shelf-edge reef habitat is small.

The creation of artificial reefs off Alabama and the deployment of petroleum platforms in the northwestern Gulf have been coincident with a shift in the fishery from a few well-known

natural reef sites on the shelf to extensive artificial reef areas off Alabama and Louisiana (Camber, 1955; Carpenter, 1965; Goodyear, 1995). We suggest that there is evidence that a high ($\pm 70\%$) proportion of the entire age 2 red snapper population occurs at these artificial habitats. These observations and the relative scarcity of high-relief natural reefs (<1.6% of the shelf bottom area) have led us and others to speculate that natural reef habitat is a limiting factor for age 2–7 fish, and that artificial reefs have increased red snapper production in the western Gulf (Szedlmayer and Shipp, 1994; Shipp, 1999; Szedlmayer, 2007). Others (e.g., Cowan et al., 1999; Patterson and Cowan, 2003) have disagreed, arguing that based on Bohnsack's (1989) gradients of reef dependency, fishing intensity, reef availability, population control mechanisms, and behavior, red snapper are merely being attracted to artificial reefs rather than experiencing increased production because of these sites.

The observations that (1) younger (<10 year) adult fish appear to show higher SF than older fish, (2) natural mortality for age 0 appears to vary with year class strength, (3) red snapper recruitment today is higher than the estimated historical maximums, (4) fishing intensity on pre-recruit fish (ages 0 and 1) has been reduced in recent years by over 65% yet age 1 abundance has not increased, and (5) the decline in abundance of age 2 fish over open habitats (shrimp trawls and longline evidence) and their disproportionate abundance at artificial reefs all suggest increased production of young red snapper that is based on habitat enhancement by artificial structures.

As described above, a large fraction of the estimated total population of age 2 red snapper has been estimated to occur at artificial reefs, a very small component of the overall high-relief reef habitat. If true, one interpretation is that age 2 fish are being differentially attracted to these habitats, perhaps due to the predominance of artificial reefs and platforms in mid-shelf zones, where juvenile red snapper are most abundant. Once there, they show high SF for months to up to a year or more. Overall, relatively high survival and SF is shown for red snapper at artificial reefs between ages 2 and 3 (see Figures 6 and 7). Abundance between age 3 and 4, however, typically declines dramatically (e.g., Figure 6), suggesting higher fishing mortality and/or increased movement. Based upon Gitschlag et al. (2003), few fish survive or remain at offshore oil and gas platforms beyond ages 5 or 6.

There are few data describing the size/age distribution of red snapper at natural reefs in the northern Gulf. However, red snapper length and age data based on scales were collected at the Flower Garden Banks, large natural reefs in the northern Gulf, by Zastrow (1984). Samples were also obtained from south Texas fishing banks (i.e., Aransas, Baker, South Baker Dream, and Big Adam Rock) and from headboats fishing out of Galveston. The Galveston fish may have come from artificial reefs (platforms) rather than natural reefs. At the East and West Flower Garden Banks, age 2 fish were scarce, and peak abundances were observed for age 3–5 fish (middle panel of Figure 11). These data suggest that red snapper populations at deep natural reefs in the northern Gulf consist mainly of fish

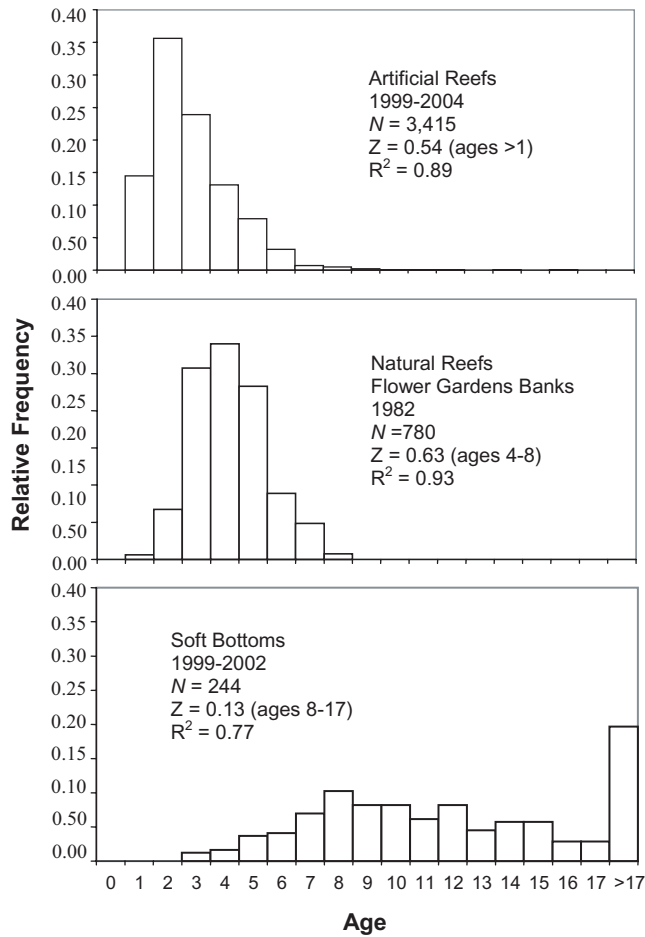

Figure 11 Age distribution of red snapper at artificial and natural reefs and over soft bottoms. Top panel based on Szedlmayer (2007), middle panel based on Zastrow (1984), and bottom panel based on Mitchell et al. (2004).

age 3 and older, whereas fish at artificial reefs are recruited at age 2.

Collectively, we suggest that prior to the proliferation of offshore oil and gas platforms and artificial reefs (e.g., pre-1980s), young new recruits occurred over open substrates between age 0 and age 2. In this habitat, natural mortality was high due to the lack of cover affording protection from predation, and the fish were subject to shrimp trawl bycatch as well (see Figure 9). Age 2 fish were commonly taken in shrimp trawls along with age 0 and age 1 fish until about 1990, which demonstrated their abundance on open habitats (Goodyear, 1995). After this stage, natural reefs in the northern Gulf would then harbor red snapper age 3 and greater (see Figure 9). We suggest that recruitment of the age 0–2 fish to the natural reefs was inhibited by the presence of adult or larger fish occupying the reefs. After age 8, red snapper would increase their foraging range to include open soft-bottom habitat because they had reached a size that reduced predation mortality.

Not surprisingly, the construction history of oil and natural gas platforms as well as other artificial reefs has corresponded to changes in habitat distribution patterns for red snapper. In 1960, there were only about 351 offshore oil and gas platforms in the northern Gulf, but these increased to 1,520 by 1970, and reached 2,540 by 1980 (Figure 12). From 1990 to the present, the number of platforms has averaged about 4,000, considering both new installations as well as removals. Catch-per-unit effort of commercial-sized red snapper in shrimp trawls (mostly age 2) fluctuated at a level of about 3 kg/1,000 nominal days fished from 1967 to 1974, after which a decline occurred through 1989 when CPUE reached a low of 0.13 kg (Figure 12). This period of decline in abundance corresponded to the increase in platforms to present-day levels. No landings were reported after 1989 because changes in fishing regulations prohibited the sale of red

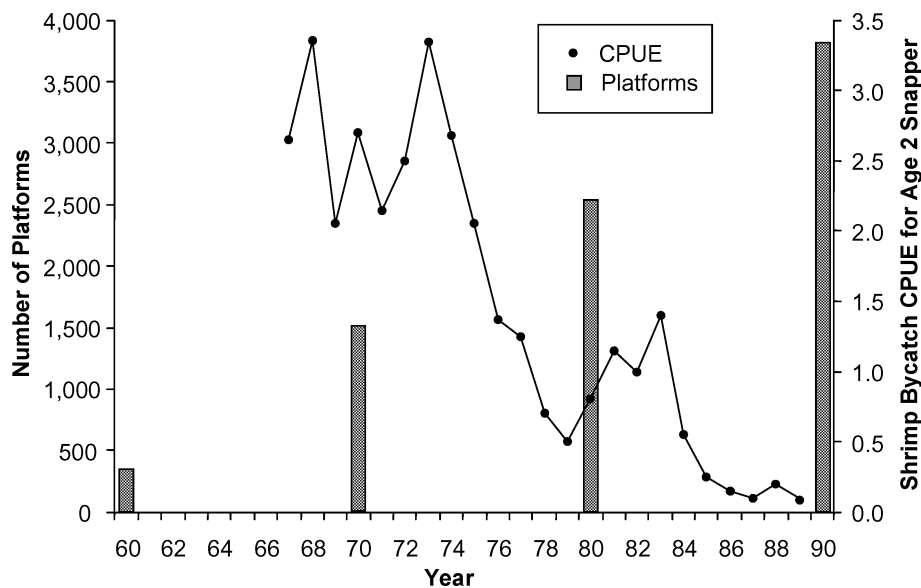

Figure 12 Catch-per-unit effort for age 2 red snapper in shrimp trawls, 1967–1989 (Goodyear, 1995), and cumulative increase of offshore oil and gas platforms in the northern Gulf of Mexico (data provided by the Minerals Management Service, New Orleans, LA).

snapper caught by shrimp trawls (Goodyear, 1995). We suggest that this increased construction of oil and gas platforms as well as other artificial habitats has provided new protective habitat for age 2 fish that would have otherwise suffered higher mortality over open habitats. Although fishing mortality can be high at these new habitats (Nieland and Wilson, 2003), we suggest that prior to their construction mortality was even higher for age 2 fish over open habitat. This being the case, we suggest that removal of production platforms and other artificial reefs will likely result in a large reduction of red snapper available to the directed fisheries.

Cordue (2005) recommended that future red snapper stock assessments should model post-recruitment density-dependent mortality, "as this is critical for determining the impact of shrimp trawl bycatch on red snapper rebuilding." We concur and have demonstrated that the information in the existing literature is consistent with the premise of density-dependent natural mortality in red snapper for at least age 0 and age 1 fish, and likely for older fish as well. If this aspect is incorporated in the assessment models, management advice may be substantially altered.

ACKNOWLEDGEMENTS

This article was enabled by funding from the Minerals Management Service (Contract 1435-01-05-39082) to VERSAR, Inc. This project provided for a literature search and data synthesis of biological information for use in management decisions concerning decommissioning of offshore oil and gas structures in the Gulf of Mexico. We especially thank Ed Weber and Jon Vølstad of VERSAR, Inc., for their support on this project. This is a contribution of the Department of Fisheries and Allied Aquacultures, Auburn University, and the Alabama Agricultural Experiment Station.

REFERENCES

- Adams, A.C., and W. C. Kendall. Report upon an investigation of the fishing grounds off the West Coast of Florida. *Bull. U.S. Fish. Commun.*, **9**: 289–312 (1891).
- Allison, P. D. *Survival Analysis Using the SAS System: A Practical Guide*. Cary, NC: SAS Institute (1995).
- Bailey, H. K., J. H. Cowan, Jr., and R. L. Shipp. Experimental evaluation of potential effects of habitat size and presence of conspecifics on habitat association by young-of-the-year red snapper. *Gulf Mex. Sci.*, **19**(2): 119–131 (2001).
- Beaumariage, D. S. Returns from the 1965 Schlitz tagging program including a cumulative analysis of previous results. *Fla. Dep. Nat. Resour. Tech. Ser.*, **59**: 1–38 (1969).
- Beaumariage, D. S., and L. H. Bullock. Biological research on snappers and groupers as related to fishery management requirements, pp. 86–94. **In:** *Colloquium on Snapper-Grouper Fishery Resources of the Western Central Atlantic Ocean* (H. R. Bullis, Jr. and A. C. Jones, Eds.). Texas A&M University Sea Grant College and Mississippi-Alabama Sea Grant Consortium (1976).
- Boland, G. S., B. J. Gallaway, J. S. Baker, and G. S. Lewbel. Ecological effects of energy developments on reef fish of the Flower Garden Banks. Report by LGL Ecological Research Associates, Inc. Nat. Mar. Fish. Serv., Galveston, TX (1983).
- Bohnsack, J. A. Are high densities of fishes at artificial reefs the result of habitat limitation or behavioral preference? *Bull. Mar. Sci.*, **44**: 631–644 (1989).
- Bradley, E., and C. E. Bryan. Life history and fishery of the red snapper (*Lutjanus campechanus*) in the northwestern Gulf of Mexico. *Proc. 27th Annu. Gulf Caribb. Fish. Inst. and 17th Annu. Int. Game Fish Res. Con.*, **27**: 77–106 (1975).
- Camber, C. I. A survey of the red snapper fishery of the Gulf of Mexico, with special reference to the Campeche banks. State of Florida Board of Conservation Marine Laboratory, No. 12: 1–64, Florida (1955).
- Carpenter, J. S. *A Review of the Gulf of Mexico Red Snapper Fishery*. U.S. Department of the Interior, Fish and Wildlife Service, Washington, D.C. (1965).
- Chapin, A. M., S. T. Szedlmayer, and R. P. Phelps. Survival and movement of hatchery-reared red snapper on artificial habitats in the northern Gulf of Mexico. *Fish. Manage. Ecol.* (in press).
- Collins, J. W. The red snapper grounds in the Gulf of Mexico. *Bull. I.S. Fish. Commun.*, **5**: 145–146 (1885).
- Collins, L. A., A. G. Johnson, and C. P. Keim. Spawning and annual fecundity of the red snapper (*Lutjanus campechanus*) from the northeastern Gulf of Mexico. **In:** *Biology, Fisheries and Culture of Tropical Groupers and Snappers* (F. Arreguin-Sanchez, J. L. Munro, M. C. Balgos, and D. Pauly, Eds.). *ICLARM Conf. Proc.*, **48**: 174–188 (1996).
- Cordue, P. Chair Report on the SEDAR7 Review Workshop, April 4–7, 2005, New Orleans, Louisiana, Section 4. **In:** *SEDAR7 2005 Stock Assessment Report of SEDAR7: Gulf of Mexico Red Snapper*. Charleston, SC, 480 pp. (2005).
- Cowan, J. H., Jr., W. Ingram, J. McCawley, B. Sauls, A. Strelcheck, and M. Woods. The attraction vs. production debate: Does it really matter from the management perspective? A response to the commentary by R. L. Shipp. *Gulf Mex. Sci.*, **17**: 137–138 (1999).
- Darnell, R. M., J. A. Kleypas, and R. E. Defenbaugh. Eastern gulf shelf bio-atlas. A study of the distribution of demersal fishes and penaeid shrimp of soft bottoms of the continental shelf from the Mississippi River Delta to the Florida Keys. U.S. Department of the Interior, Outer Continental Shelf Study MMS 86-0041, New Orleans, LA (1987).
- Diamond, S. L., M. Campbell, D. Olson, L. Panto, Y. Wang, J. Zeplin, and S. Qualia. Movers and stayers: Individual variability in site fidelity and movements of red snapper off Texas. **In:** *Red Snapper Ecology and Fisheries in the U.S. Gulf of Mexico* (W. F. Patterson, J. H. Cowan, Jr., G. R. Fitzhugh, and D. L. Nieland, Eds.). *Am. Fish. Soc. Symp.*, **60**: 163–188 (2007).
- Dufrene, T. A. Geological variability and Holocene sedimentary record on the northern Gulf of Mexico inner to mid-continental shelf. MS Thesis, Louisiana State University, 100 pp. Baton Rouge, LA (2005).
- Fable, W. A., Jr. Tagging studies of red snapper (*Lutjanus campechanus*) and vermilion snapper (*Rhomobolites aurorubens*) off the South Texas coast. *Contrib. Mar. Sci.*, **23**: 115–121 (1980).
- Fischer, A. J., M. S. Baker, Jr., and C. A. Wilson. Red snapper (*Lutjanus campechanus*) demographic structure in the northern Gulf of Mexico based on spatial patterns in growth rates and morphometrics. *Fish. Bull.*, **102**: 593–603 (2004).

- Frazier, T. K., and W. J. Lindberg. Refuge spacing similarly affects reef-associated species from three phyla. *Bull. Mar. Sci.*, **55**(2–3): 388–400 (1994).
- Futch, R. B., and G. E. Burger. Age, growth, and production of red snapper in Florida waters, pp. 165–184. **In:** *Proceedings: Colloquium on Snapper-Grouper Fishery Resources of the Western Central Atlantic Ocean* (H. R. Bullis, Jr. and A. C. Jones, Eds.). Texas A&M University Sea Grant Coll. and Mississippi-Alabama Sea Grant Consortium. Florida Sea Grant Program Report 17. (1976).
- Galloway, B. J. An ecosystem analysis of oil and gas development on the Texas-Louisiana continental shelf. U.S. Fish and Wildlife Service, Office of Biological Services, Washington, DC. FWS/OBS-81/27, 89 pp. (1981).
- Galloway, B. J., and J. G. Cole. Cumulative ecological significance of oil and gas structures in the Gulf of Mexico: A Gulf of Mexico fisheries habitat suitability model—Phase II Model Description. U.S. Department of the Interior, U.S. Geol. Sur., Biol. Res. Div., USGS/BRD/CR-1997–0009 and Min. Manage. Serv., Gulf Mex. OCS Region, New Orleans, LA, OCS Study MMS 97–0044, 109 pp. (1997).
- Galloway, B. J., J. G. Cole, R. Meyer, and P. Roscigno. Delineation of essential habitat for juvenile red snapper in the northwestern Gulf of Mexico. *Trans. Am. Fish. Soc.*, **128**: 713–726. (1999).
- Galloway, B. J., W. J. Gazey, J. G. Cole, and R. G. Fechhelm. Estimation of potential impacts from offshore liquefied natural gas terminals on red snapper and red drum fisheries in the Gulf of Mexico: An alternative approach. *Trans. Am. Fish. Soc.*, **136**: 655–677 (2007).
- Galloway, B. J., L. R. Martin, R. L. Howard, G. S. Boland, and G. D. Dennis. Effects on artificial reef and demersal fish and macrocrustacean communities, pp. 237–299. **In:** *Environmental Effects of Offshore Oil Production: The Buccaneer Gas and Oil Field Study* (B. S. Middleditch, Ed.). Houston, TX: Plenum Press (1981).
- Gazey, W. J., B. J. Galloway, J. G. Cole, and D. A. Fournier. Age composition, growth, and density dependent mortality in juvenile red snapper estimated from observer data from the Gulf of Mexico penaeid shrimp fishery. *N. Am. J. Fish. Manage.*, Vol. 28 (2008).
- Gitschlag, G. R., M. J. Schirripa, and J. E. Powers. Impacts of red snapper mortality associated with the explosive removal of oil and gas structures on stock assessments of red snapper in the Gulf of Mexico. **In:** *Fisheries, reefs, and offshore development*, (D. R. Stanley and A. Scarborough-Bull, Eds.). *Amer. Fish. Soc. Symp.*, **36**: 83–94 (2003).
- Gold, J. R., and E. Salliant. Population structure of red snapper in the northern Gulf of Mexico. **In:** *Red snapper ecology and fisheries in the U.S. Gulf of Mexico* (W. F. Patterson, J. H. Cowan, Jr., G. R. Fitzhugh, and D. L. Nieland, Eds.). *Am. Fish. Soc. Symp.*, **60**: 201–216 (2007).
- Goodyear, C. P. Red snapper in U.S. waters of the Gulf of Mexico. Nat. Mar. Fish. Serv., SE Fish. Sci. Center, Miami Laboratory, Miami, FL, MIA-95/96/05 (1994).
- Goodyear, C. P. Red snapper in U.S. waters of the Gulf of Mexico. Natl. Oceanic Atmos. Adm., Nat. Mar. Fish. Serv., SE Fish. Sci. Center, Miami, FL, 171 pp. (1995).
- Hastings, R. W., L. H. Ogren, and M. T. Mabry. Observations on the fish fauna associated with offshore platforms in the northwestern Gulf of Mexico. *Fish. Bull.*, **74**: 387 (1976).
- Hoenig, J. M. Estimating mortality rate from maximum observed age. Internal Council for the Exploration of the Sea 1982. Meeting collected papers. ICES, Copenhagen (1983).
- Kennicutt, M. C., W. W. Schroeder, and J. M. Brooks. Temporal and spatial variations in sediment characteristics on the Mississippi-Alabama continental shelf. *Cont. Shelf Res.*, **15**: 1–18 (1995).
- LGL Ecological Research Associates, Inc. Final annual effort report for January–December 2006. Final report to the Nat. Mar. Fish. Serv., Galveston, TX, 17 pp. (2007).
- Lindberg, W. J., T. K. Frazer, and G. R. Stanton. Population effects of refuge dispersion for adult stone crabs (Xanthidae, *Menippe*). *Mar. Ecol. Prog. Ser.*, **66**: 239–249 (1990).
- Lindberg, W. J., T. K. Frazer, K. M. Portier, F. Vose, J. Loftin, D. J. Murie, D. M. Mason, B. Nagy, and M. K. Hart. Density-dependent habitat selection and performance by a large mobile reef fish. *Ecol. Appl.*, **16**: 731–746 (2006).
- Lingo, M. E., and S. T. Szedlmayer. The influence of habitat complexity on reef fish communities in the northeastern Gulf of Mexico. *Environ. Biol. Fish.*, **76**: 71–80 (2006).
- Ludwick, J. C. Sediments in the northwestern Gulf of Mexico, pp. 204–240. **In:** *Papers in Geology: Shepard Commemorative Volume* (R. L. Miller, Ed.). New York: MacMillan (1964).
- Lyczkowski-Shultz, J., and D. S. Hanisko. A time series of observations on red snapper larvae from SEAMAP surveys, 1982–2003: Seasonal occurrence, distribution, abundance, and size. **In:** *Red Snapper Ecology and Fisheries in the U.S. Gulf of Mexico* (W. F. Patterson, J. H. Gowan, Jr., G. R. Fitzhugh, and D. L. Nieland, Eds.). *Am. Fish. Soc. Symp.*, **60**: 3–24 (2007).
- Lyczkowski-Shultz, J., D. S. Hanisko, and G. W. Ingram, Jr. The potential for incorporating a larval index of abundance for stock assessment of red snapper, *Lutjanus campechanus*. Nat. Mar. Fish. Serv., SEDAR7-DW-14, Miami, FL. Available at www.sefsc.noaa.gov/sedar/download/SEDAR7_DW14.pdf?id=DOCUMENT (2005).
- Manooch, C. S., III, and J. C. Potts. Age and growth of red snapper, *Lutjanus campechanus*, Lutjanidae, collected along the southeastern United States from North Carolina through the east coast of Florida. *J. Elisha Mitchell Sci. Soc.*, **113**: 111–122 (1997).
- McBride, R. A., L. C. Anderson, A. Tudoran, and H. H. Roberts. *Holocene Stratigraphic Architecture of a Sand-Rich Shelf and the Origin of Linear Shoals: Northeastern Gulf of Mexico*. Soc. Sed. Geol., Special Publication No. 64, pp. 95–126 (1999).
- McCawley, J. R., and J. H. Cowan. Seasonal and size specific diet and prey demand of red snapper on artificial reefs. **In:** *Red Snapper Ecology and Fisheries in the U.S. Gulf of Mexico* (W. F. Patterson, J. H. Cowan, Jr., G. R. Fitzhugh, and D. L. Nieland, Eds.). *Am. Fish. Soc. Symp.*, **60**: 77–104 (2007).
- McCawley, J. R., J. H. Cowan, Jr., and R. L. Shipp. Feeding periodicity and prey habitat preference of red snapper *Lutjanus campechanus* (Poey, 1860) on Alabama artificial reefs. *Gulf Mex. Sci.*, **24**(1–2): 14–27 (2006).
- Minton, R. V., and S. R. Heath. Alabama's artificial reef program: Building oasis in the desert. *Gulf Mex. Sci.*, **1**: 105–106 (1998).
- Minton, R. V., J. P. Hawke, and W. T. Tatum. Hormone induced spawning of red snapper, *Lutjanus campechanus*. *Aquaculture*, **30**: 363–368 (1983).
- Mitchell, K. M., T. Henwood, G. R. Fitzhugh, and R. J. Allman. Distribution, abundance, and age structure of red snapper (*Lutjanus campechanus*) caught on research longlines in U.S. Gulf of Mexico. *Gulf Mex. Sci.*, **22**(2): 164–172 (2004).
- Moseley, F. N. Biology of the red snapper, *Lutjanus aya* Bloch, of the northwestern Gulf of Mexico. *Publ. Inst. Mar. Sci.*, University of Texas, **11**: 90–101 (1966).

- National Oceanic and Atmospheric Administration (NOAA). *Gulf of Mexico Coastal and Ocean Zones Strategic Assessment: Data Atlas*. U.S. Department of Commerce, Washington, DC (1985).
- Nelson, R. S., and C. S. Manooch, III. Growth and mortality of red snappers in the west-central Atlantic Ocean and northern Gulf of Mexico. *Trans. Am. Fish. Soc.*, **111**: 465–475 (1982).
- Nichols, S., G. Pellegrin, Jr., and G. W. Ingram, Jr. Estimation of juvenile M for red snapper based on SEAMAP survey data. Nat. Mar. Fish. Serv., SEDAR7-AW-15, Miami, FL. Available at www.sefsc.noaa.gov/sedar/download/SEDAR7_AW15.pdf?id=DOCUMENT (2005).
- Nieland, D. L., and C. A. Wilson. Red snapper recruitment to and disappearance from oil and gas platforms in the northern Gulf of Mexico. **In:** Fisheries, Reefs, and Offshore Development (D. R. Stanberg and A. Scarborough-Bull, Eds.). *Am. Fish. Soc. Symp.*, **36**: 73–81 (2003).
- Ouzts, A. C., and S. T. Szedlmayer. Diel feeding patterns of red snapper on artificial reefs in the north-central Gulf of Mexico. *Trans. Am. Fish. Soc.*, **132**: 1186–1192 (2003).
- Parker, R. O., Jr., D. R. Colby, and T. D. Willis. Estimated amount of reef habitat on a portion of the U.S. South Atlantic and Gulf of Mexico continental shelf. *Bull. Mar. Sci.*, **33**(4): 935–940 (1983).
- Parker, S. J., A. W. Schultz, and W. W. Schroeder. Sediment characteristics and seafloor topography of a palimpsest shelf, Mississippi-Alabama continental shelf. **In:** Quaternary coasts of the United States: Marine and lacustrine systems (C. H. Fletcher III and J. F. Wehlimiller, Eds.). *SEPM Special Publ.*, **48**: 243–251 (1992).
- Patterson, W. F. Aspects of the population ecology of red snapper *Lutjanus campechanus* in an artificial reef area off Alabama. Ph.D. Dissertation, University of South Alabama, Mobile, AL, 164 pp. (1999).
- Patterson, W. F., III., and J. H. Cowan. Site fidelity and dispersion of red snapper associated with artificial reefs in the northern Gulf of Mexico. *Am. Fish. Soc. Symp.*, **36**: 181–193 (2003).
- Patterson, W. F., III., J. C. Watterson, R. L. Shipp, and J. H. Cowan, Jr. Movement of tagged red snapper in the northern Gulf of Mexico. *Trans. Am. Fish. Soc.*, **130**: 533–545 (2001a).
- Patterson, W. F., J. H. Cowan, Jr., C. A. Wilson, and R. L. Shipp. Age and growth of red snapper, *Lutjanus campechanus*, from an artificial reef area off Alabama in the northern Gulf of Mexico. *Fish. Bull.*, **99**: 617–627 (2001b).
- Peabody, M. B. The fidelity of red snapper (*Lutjanus campechanus*) to petroleum platforms and artificial reefs in the northern Gulf of Mexico. MS Thesis, Louisiana State University, Baton Rouge, LA (2004).
- Peabody, M. B. and C. A. Wilson. Fidelity of red snapper (*Lutjanus campechanus*) to petroleum platforms and artificial reefs in the northern Gulf of Mexico. U.S. Department of the Interior, Min. Manage. Serv., Gulf of Mexico OCS Region, New Orleans, LA, OCS Study MMS 2006–005, 64 pp. (2006).
- Piko, A. A., and S. T. Szedlmayer. Effects of habitat complexity and predator exclusion on the abundance of juvenile red snapper. *J. Fish Biol.*, **70**: 758–769 (2007).
- Prytherch, H. F. A descriptive survey of the bottom longline fishery in the Gulf of Mexico. Nat. Oceanic Atmos. Admin. Tech. Mem. NMFS-SEFC-122 (1983).
- Rabalais, N. N., S. C. Rabalais, and C. R. Arnold. Description of eggs and larvae of laboratory reared red snapper (*Lutjanus campechanus*). *Copeia* 1980, **4**: 704–708 (1980).
- Ransom Myers' Stock Recruitment Database. <http://fish.dal.ca/~myers/welcome.html> (2007).
- Render, J. H. The life history (age, growth, and reproduction) of red snapper (*Lutjanus campechanus*) and its affinity for oil and gas platforms. Ph.D. Dissertation, Louisiana State University, Baton Rouge, LA, 76 pp. (1995).
- Rooker, J. R., A. M. Landry, Jr., B. W. Geary, and J. A. Harper. Assessment of a shell bank and associated substrates as nursery habitat of post-settlement red snapper. *Estuar. Coast. Shelf Sci.*, **59**: 653–661 (2004).
- Royce, W. E. *Introduction to Fishery Sciences*. New York: Academic Press (1972).
- Salliant, E., and J. R. Gold. Population structure and variance effective size of red snapper (*Lutjanus campechanus*) in the northern Gulf of Mexico. *Fish. Bull.*, **104**: 136–148 (2004).
- Schroeder, W. W., A. W. Shultz, and J. J. Dindo. Inner-shelf hardbottom areas, northeastern Gulf of Mexico. *Gulf Coast Assoc. Geol. Soc., Trans.*, **38**: 535–541 (1988).
- Schroeder, W. W., A. W. Shultz, and O. H. Pilkey. Late Quaternary oyster shells and sea-level history, inner shelf, northeast Gulf of Mexico. *J. Coast. Res.*, **11**: 241–258 (1995).
- Schroepfer, R. L., and S. T. Szedlmayer. Estimates of residence and site fidelity for red snapper *Lutjanus campechanus* on artificial reefs in the northeastern Gulf of Mexico. *Bull. Mar. Sci.*, **78**(1): 93–101 (2006).
- SEDAR7. *Stock Assessment Report of SEDAR 7, Gulf of Mexico Red Snapper*. Charleston, SC, 480 pp. (2005).
- Shipp, R. L. The artificial reef debate: Are we asking the wrong questions? *Gulf Mex. Sci.*, **17**(1): 51–55. (1999).
- Siegel, D. M. Aspects of the feeding ecology of snapper fishes (Lutjanidae). MS Thesis, University of West Florida, Pensacola, FL (1983).
- Stanley, D. R. Seasonal and spatial abundance and size distribution of fishes associated with a petroleum platform in the northern Gulf of Mexico. Ph.D. Dissertation, Louisiana State University, Baton Rouge, LA (1994).
- Stanley, D. R. and C. A. Wilson. Seasonal and spatial variation in the biomass and size frequency distribution of fish associated with oil and gas platforms in the northern Gulf of Mexico. **In:** Fisheries, Reefs, and Offshore Development (D. R. Stanley and A. Scarborough-Bull, Eds.). *Am. Fish. Soc. Symp.*, **36**: 123–153 (2003).
- Stearns, S. On the position and character of the fishing grounds of the Gulf of Mexico. *Bull. U.S. Fish. Commun.*, **4**: 289–290 (1884).
- Strelcheck, A. J., J. H. Cowan, Jr., and W. F. Patterson, III. Site fidelity, movement, and growth of red snapper, *Lutjanus campechanus*: Implications for artificial reef management. **In:** Red Snapper Ecology and Fisheries in the U.S. Gulf of Mexico, (W. F. Patterson, J. H. Cowan, Jr., G. R. Fitzhugh, and D. L. Nieland, Eds.). *Am. Fish. Soc. Symp.*, **60**: 147–162 (2007).
- Szedlmayer, S. T. An evaluation of the benefits of artificial habitats for red snapper, *Lutjanus campechanus*, in the northeast Gulf of Mexico. *Proc. Gulf Caribb. Fish. Inst.*, **59**: 223–230 (2007).
- Szedlmayer, S. T. Ultrasonic telemetry of red snapper, *Lutjanus campechanus*, at artificial reef sites in the northeast Gulf of Mexico. *Copeia* 1997, **4**: 846–850 (1997).
- Szedlmayer, S. T., and J. Conti. Nursery habitats, growth rates, and seasonality of age 0 red snapper, *Lutjanus campechanus*, in the northeast Gulf of Mexico. *Fish. Bull.*, **97**: 626–635 (1999).

- Szedlmayer, S. T., and J. C. Howe. Substrate preference in age 0 red snapper, *Lutjanus campechanus*. *Environ. Biol. Fish.*, **50**: 203–207 (1997).
- Szedlmayer, S. T., and J. D. Lee. Diet shifts of juvenile red snapper (*Lutjanus campechanus*) with changes in habitat and fish size. *Fish. Bull.*, **102**: 366–375 (2004).
- Szedlmayer, S. T., and R. L. Schroepfer. Long-term residence of red snapper on artificial reefs in the northeastern Gulf of Mexico. *Trans. Am. Fish. Soc.*, **134**: 315–325 (2005).
- Szedlmayer, S. T., and R. L. Shipp. Movement and growth of red snapper, *Lutjanus campechanus*, from an artificial reef area in the Northeastern Gulf of Mexico. *Bull. Mar. Sci.*, **55(2–3)**: 887–896 (1994).
- Topp, R. W. *The Tagging of Fishes in Florida, 1962 Program*. Florida State Board of Conservation, Marine Laboratory, Maritime Base, St. Petersburg, FL (1963).
- Watterson, J. C., W. F. Patterson III, R. L. Shipp, and J. H. Cowan, Jr. Movement of red snapper, *Lutjanus campechanus*, in the north central Gulf of Mexico: Potential effects of hurricanes. *Gulf Mex. Sci.*, **1**: 92–104 (1998).
- Wells, R. J. D. The effects of trawling and habitat use on red snapper and the associated community. Ph.D. Dissertation. Department of Oceanography and Coastal Sciences, Louisiana State University, LA, 179 pp. (2007).
- Wilson, C. A., and D. L. Nieland. Age and growth of red snapper, *Lutjanus campechanus*, from the northern Gulf of Mexico off Louisiana. *Fish. Bull.*, **99**: 653–664 (2001).
- Workman, I. K., and D. G. Foster. Occurrence and behavior of juvenile red snapper, *Lutjanus campechanus*, on commercial shrimp fishing grounds in the northeastern Gulf of Mexico. *Mar. Fish. Rev.*, **56(2)**: 9–11 (1994).
- Workman, I., A. Shah, D. Foster, and B. Hataway. Habitat preferences and site fidelity of juvenile red snapper (*Lutjanus campechanus*). International Council on the Exploration of the Sea. *J. Mar. Sci.*, **59**: S43–S50 (2002).
- Zastrow, C. E. Age and growth of the red snapper, *Lutjanus campechanus*, and the vermilion snapper, *Rhomboplites aurorubens*, from the northwestern Gulf of Mexico. MS Thesis, Texas A&M University, College Station, TX, 81 pp. (1984).